

RADIO & TELEVISION RETAILING

Planning Ahead —

What About Sales
After Christmas?

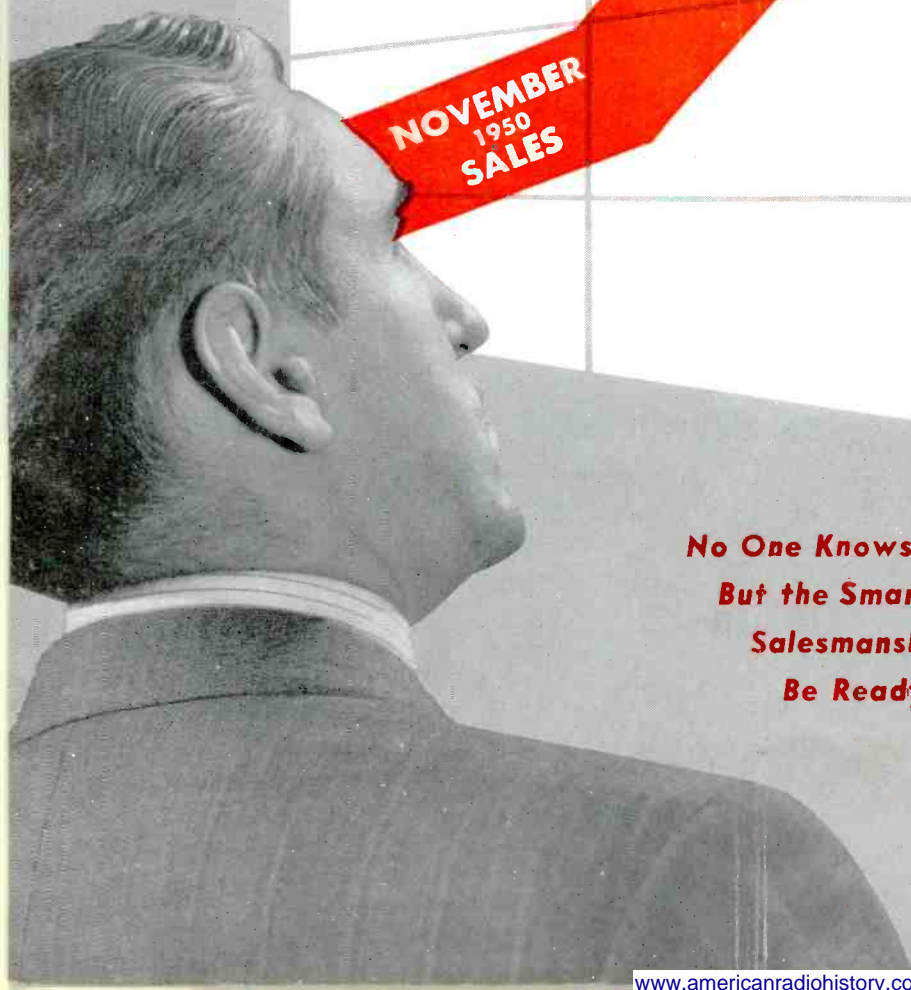

NOVEMBER
1950
SALES

DECEMBER
1950
SALES

Will they climb still higher?

Will they stay as they are?

Will sales drop sharply?

No One Knows What Will Happen,
But the Smart Dealer Will Keep His
Salesmanship at a High Level in Order to
Be Ready for Any Kind of Market

November • 1950

CALDWELL-CLEMENTS, INC.

Top Value TV.

**sell the set
that stays sold**

precision manufacturing
makes the difference

look at these features

- 16" RECTANGULAR TUBE
- ONE KNOB TUNING
- SUPER POWER CHASSIS
- "DECORATORS" CABINET

\$299⁹⁵

Prices slightly higher
West of the Rockies



MODEL
16CI

air king

has everything!

NATIONAL DISPLAY
1454 Merchandise Mart,
Chicago

AIR KING PRODUCTS CO. INC. 170-53rd St. Brooklyn 32, N.Y.

RADIO & TELEVISION RETAILING

IN THIS ISSUE

NOVEMBER, 1950

Including "RADIO & TELEVISION"
"RADIO & TELEVISION TODAY"
and "ELECTRICAL RETAILING"

ORESTES H. CALDWELL
Editorial Director

M. CLEMENTS
Publisher

JOHN L. STOUTENBURGH
Executive Editor

EDWARD A. CAMPBELL
Technical Editor

JOHN G. MCGEOY
Assistant Editor

CHARLES F. DREYER
Art Director

BUSINESS DEPARTMENT

M. H. NEWTON
Sales Manager

HOWARD A. REED
Asst. Sales Mgr.

A. O'ROURKE
Production Supervisor

N. McALLISTER
Director, Reader Service

**BRANCH OFFICE
CHICAGO 6**

S. M. GASKINS, Western Manager
ANDREW M. GENT, District Manager
201 N. Wells St., Randolph 6-9225

CIRCULATION DEPARTMENT

B. V. SPINETTA
Circulation Director

W. W. SWIGERT
Credit Manager

RADIO & TELEVISION RETAILING*

November, 1950, Vol. 52, No. 5, 35 cents a copy. Published monthly by Caldwell-Clements, Inc., 480 Lexington Ave., New York 17, N. Y. PL. 9-7880. M. Clements, President; Orestes H. Caldwell, Treasurer. Subscription rates United States and U. S. Possessions \$2.00 for one year, \$3.00 for two years, \$4.00 for three years. Canada \$3.00 for one year, \$4.00 for two years, \$5.00 for three years. Pan American Countries \$4.00 for one year, \$5.00 for two years, \$6.00 for three years. All other countries \$5.00 for one year, \$7.50 for two years, \$10.00 for three years. Printed in U.S.A. Entered as second class matter at the Post Office at New York, N. Y., under the act of March 3, 1879.

*Trade-Mark Reg. U. S. Pat. Off.
Copyright 1950 by

CALDWELL-CLEMENTS, Inc.
Publishers also of TELE-TECH

★ *AM, FM, Television*

COVER — What About Sales After Christmas?

WHAT'S AHEAD—In Radio, Appliances, Records and Television.....	37, 42, 43
ANSWERING YOUR QUESTIONS ABOUT COLOR TV.....	38, 39
VIEWING THE CHRISTMAS MARKET.....	44, 45
CHANGING MARKET.....	46, 47
USE TV SHOWS TO SELL SETS.....	48, 49
LATEST TV AND RADIO SETS.....	54
TV MARCHES ON!.....	50
BETTER BUSINESS BUILDERS.....	73
SALES TIPS & PROFIT POINTERS.....	58
CHRISTMAS DECORATION IDEAS.....	60
TV SPEARHEADS SALES.....	62
2 MILLION DOLLAR VOLUME ON TV.....	64

★ *Records, Phonographs, Accessories*

PROFITABLE PLAN FOR SELLING MORE RECORDS.....	52, 53
CHRISTMAS DECORATION IDEAS.....	60
NEWS OF THE RECORD FIELD.....	94

★ *Electrical Appliances*

BETTER BUSINESS BUILDERS.....	73
SALES TIPS & PROFIT POINTERS.....	58
APPLIANCE & TELEVISION RETAILING.....	56

★ *Servicing and Sound*

HOW TO INCREASE YOUR SOUND BUSINESS.....	75
NEW CIRCUITS AND CIRCUIT CHANGES.....	76, 77
CRYSTAL DIODES REPLACE TUBES IN NEW TV SETS.....	78, 79
QUESTIONS & ANSWERS ON COLOR TV.....	80
NEW AIDS FOR THE SERVICER.....	68, 69, 72

Photo Credit

Ewing Galloway.....	Cover
General Electric Lamp Division.....	pages 44, 45
Frederic Lewis.....	inset, page 45
A. Devaney.....	page 73, left
P. Gendreau.....	page 73, top



CALDWELL-CLEMENTS, INC.
480 LEXINGTON AVE., NEW YORK, N. Y.

Get Aboard Television's Hottest Profit Bandwagon!

REPRINT OF TELE KING ADVERTISEMENT NEW YORK "TIMES"
—SUNDAY, OCTOBER 15th

FROM EVERY CITY, TOWN AND VILLAGE DEPENDABLE TELEVISION DEALERS REPORT

The Buying Swing is to

Tele King

Clear Channel



PERFECTED TELEVISION

Tele King is One of the Nation's Largest Producers of Television Receivers



17" TELE KING BARRY BORSARI COMBINATION MODEL 11115

17" TELE KING LINDA BAE COSTUME MODEL 11115

19" TELE KING DWIGHT BOSWELL EXHIBITION MODEL 81115

18" TELE KING DWIGHT BOSWELL EXHIBITION MODEL 81115



See these amazing New Tele King models at your nearest dealer! You'll discover why the "Buying Swing" is to Tele King!

Your Tele King Dealer Offers Easy Terms



16" TELE KING MODEL 81115 TELEVISION MODEL 81115

17" TELE KING CONSOLI MODEL 1111C

★ ★ ★ NEW YORK'S LEADING TELEVISION DEALERS INVITE YOU TO SEE THE NEW 1951 TELE KING PERFECTED TELEVISION ★ ★ ★

DEALER	ADDRESS
BROOKLYN	...
MANHATTAN	...
...	...

DEALER	ADDRESS
...	...
...	...

DEALER	ADDRESS
...	...
...	...

DEALER	ADDRESS
...	...
...	...

DEALER	ADDRESS
...	...
...	...

DEALER	ADDRESS
...	...
...	...

DEALER	ADDRESS
...	...
...	...



20" Model 201: Black rectangular no-glare tube, mahogany veneer cabinet.

Millions of Prospective Television Buyers Will Read the Sensational News About Tele King

On Sunday, October 15th, the first of a series of powerful Tele King newspaper advertisements appeared in the New York Times. This is the opening gun of Tele King's contemplated nationwide advertising campaign that will reach prospective television buyers, coast to coast.

TELE KING CORPORATION

DEALERS FROM EVERY CITY, TOWN AND VILLAGE REPORT

*The Buying
Swing is to*

Tele King



**PERFECTED
TELEVISION**



17" Model 117LO: Black rectangular no-glare tube, magnificently styled console, limed oak finish.



19" Model 919CAF: 6-way combination . . . 19" television, AM-FM radio, 3-speed automatic record player. Authentically styled period cabinet of walnut veneers with full length flush folding doors.

***Tele King Is One of the
Nation's Largest Producers
of Television Receivers***

There must be some mighty good reasons why Tele King sales are going UP, UP and UP in dealer stores everywhere! The first, Tele King's "eye-catching" styling . . . the second, Tele King's high contrast no-glare pictures . . . the third, Tele King's brilliant trouble-free performance . . . the fourth, Tele King's unbeatable low prices. Don't miss out on your biggest profit opportunity! Get aboard the fast moving Tele King bandwagon now! Your Tele King distributor is waiting to hear from you!

601 WEST 26th ST., NEW YORK 1, N.Y.

..... "Sells for me...

BIG!"

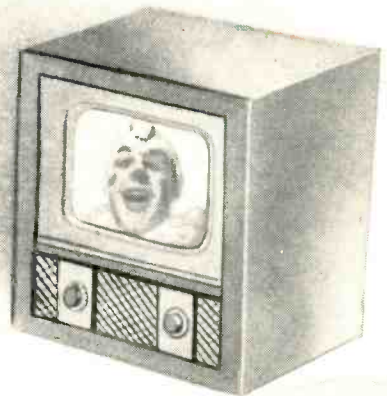

"G.E.'s the hottest name in tubes. My turnover is evidence."

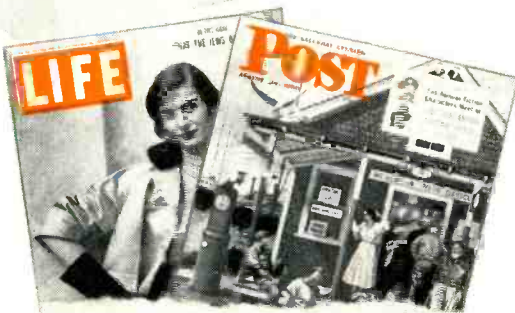

NOW... full page G-E tube ads

IN "LIFE" AND THE "SAT. EVE. POST"!

Another big boost to your sales! Millions of radio-TV owners are reading, in national magazines, the dramatic story of G-E tube leadership. YOU benefit!

"THIS handy tube merchandiser has the G-E monogram *big* on top . . . illuminated, too. That's why it makes buyers out of callers—turns my tube stock into cash for a mighty fine profit showing!" You hear this everywhere from radio-TV servicemen who have given the green light to G-E product popularity . . . And General Electric's success pattern for dealers is so easy to follow! Waiting for you is the attractive new 200-tube Selector-Salesman shown here. Ask your G-E tube distributor how to obtain one; then rub your eyes as tubes become dollars, faster than ever before! . . . Other G-E colorful displays and signs, hard-hitting promotion pieces, high-voltage advertising aids—all are ready to help you SELL. Phone, wire, or write your distributor today! *Electronics Department, General Electric Company, Schenectady 5, New York.*

You can put your confidence in—

GENERAL  ELECTRIC

181-JAB

Now Dealers Everywhere Agree

PHILCO *BALANCED BEAM TELEVISION*

is

FIRST in **QUALITY**

FIRST in **PERFORMANCE**

FIRST in **VALUE**

IT was the overwhelming verdict last June; it's even more emphatic today . . . Philco, *the industry leader for 20 straight years*, has **TAKEN OVER IN TELEVISION!**

Yes, the smoke has cleared away since Philco first introduced its line to 5,000 dealers at a history-making convention in Atlantic City. Now the height of the season is at hand, and you hear it from all sides . . . Philco for 1951 is the "HOTTEST" line in history, with the highest quality television sets ever built. Once again Philco pioneering research has *taken the lead*, spearheaded by an exclusive invention that *sets the pace* for 1951.

IT'S ANOTHER PHILCO "FIRST"—Balanced Beam *True-Focus* television! Every 1951 Philco has this sweeping advance that brings for the first time *uniform focus* over the entire picture. No blurred edges; no smeared images! And it's exclusive—only Philco has Balanced Beam.

YET PHILCO DID NOT STOP HERE in designing its 1951 television line. Philco created a new concept of chassis design—the Custom-Duplex Chassis—acclaimed everywhere as the greatest forward step in television design yet achieved. And, of course, Philco for 1951 brings you the now famous Electronic Built-In Aerial that outperforms all others as much as 3 to 1 . . . the revolutionary development that brought package merchandising to television. In many other ways, too, Philco's progressive engineering and constructive merchandising reveal themselves in its 1951 line, with improvements on all counts . . . and with models for every preference, every shade of demand.

YES, THE PHILCO OF OLD . . . the Philco that dealers have looked to as *the industry leader for 20 straight years* . . . has taken over in television, with a line that is hailed by all—*First in Quality, First in Performance, First in Value!*

**TWO NEW
FADA TV MODELS**
that bring **BIG** screen reception beyond compare

Brand NEW
20 Inch Console

Model S20C10-20" rectangular **GLARE-FREE** screen side door DeLuxe Console

Beautiful Custom-Built Mahogany Veneer . . .

Big 10 Inch Concert Quality Speaker . . .

YES . . . 20 Inch rectangular glare-free filter glass black tube. Exquisite front control side door DeLuxe cabinet. Clear, sharp pictures with FM sound that is unmatched with its 10 inch concert grand speaker. Built-in 'FADA-SCOPE' antenna. It's the last word in BIG screen televiewing . . . it's the last word in beauty.

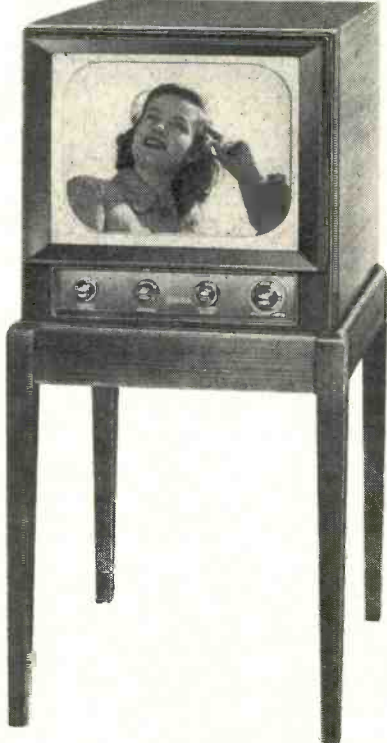

Front controls are on the side of cabinet for easy handling.

- *Fast Automatic Gain Control.*
- *Full 12 channel continuous coverage with lock-in picture and sound . . . as easy to tune as a radio set.*
- *Automatic frequency Control Horizontal and Stabilized Vertical Holds.*

Brand NEW **17 Inch Rectangular tube Table Model TV Receiver**

MODEL S7T65 . . . Beauty, superior performance and really **BIG, BIG** 17 inch rectangular screen televiewing. Here is a beautifully plastic moulded picture frame cabinet front with buffed yellow jeweler's gold-like front control plate and mahogany veneer table model cabinet. Built-In 'FADA-SCOPE' antenna. Matching table available.

FADA RADIO & ELECTRIC CO. INC.

THE NEW 1951 FADA TV

smartly styled . . . tops for performance and value!

MODEL S1055 . . . 16 Inch rectangular tube, custom-built Deluxe console. Built-in 'FADA-SCOPE' antenna. 10 inch concert quality speaker. Model S1055X is same as above except it has 16 Inch round tube. Clear, sharp pictures.



MODEL S-C20 . . . 14 Inch rectangular tube Deluxe console of rich mahogany veneers with tilt-back angle front panel for downward viewing. Built-in 'FADA SCOPE' antenna. 10 inch concert quality speaker.



MODEL S6C55 . . . 16 Inch rectangular glare-free filter glass screen. Gorgeous mahogany veneer deluxe console cabinet with closing doors. Tilt-back angle front panel for downward viewing. Full range 10 inch concert quality fidelity speaker. Built-in 'FADA-SCOPE' antenna.



MODEL S4C40 . . . 14 Inch rectangular glare-free filter glass screen. Built-in 'FADA-SCOPE' antenna. AGC circuit chassis. Beautiful cabinet console with closing doors. Tilt-back angle front panel for downward viewing. 10 Inch concert quality speaker.



MODEL S4T15 . . . 14 Inch rectangular tube table model mahogany veneer receiver with moulded plastic picture frame front. An ace performer in all areas. Built-in 'FADA-SCOPE' antenna. Matching table available.



MODEL S1060 . . . 16 Inch rectangular tube table model receiver. Beautiful matched grain mahogany veneer custom-built cabinet. Built-in 'FADA-SCOPE' antenna. Matching table available.



BELLEVILLE, NEW JERSEY

Only G.E. gives you

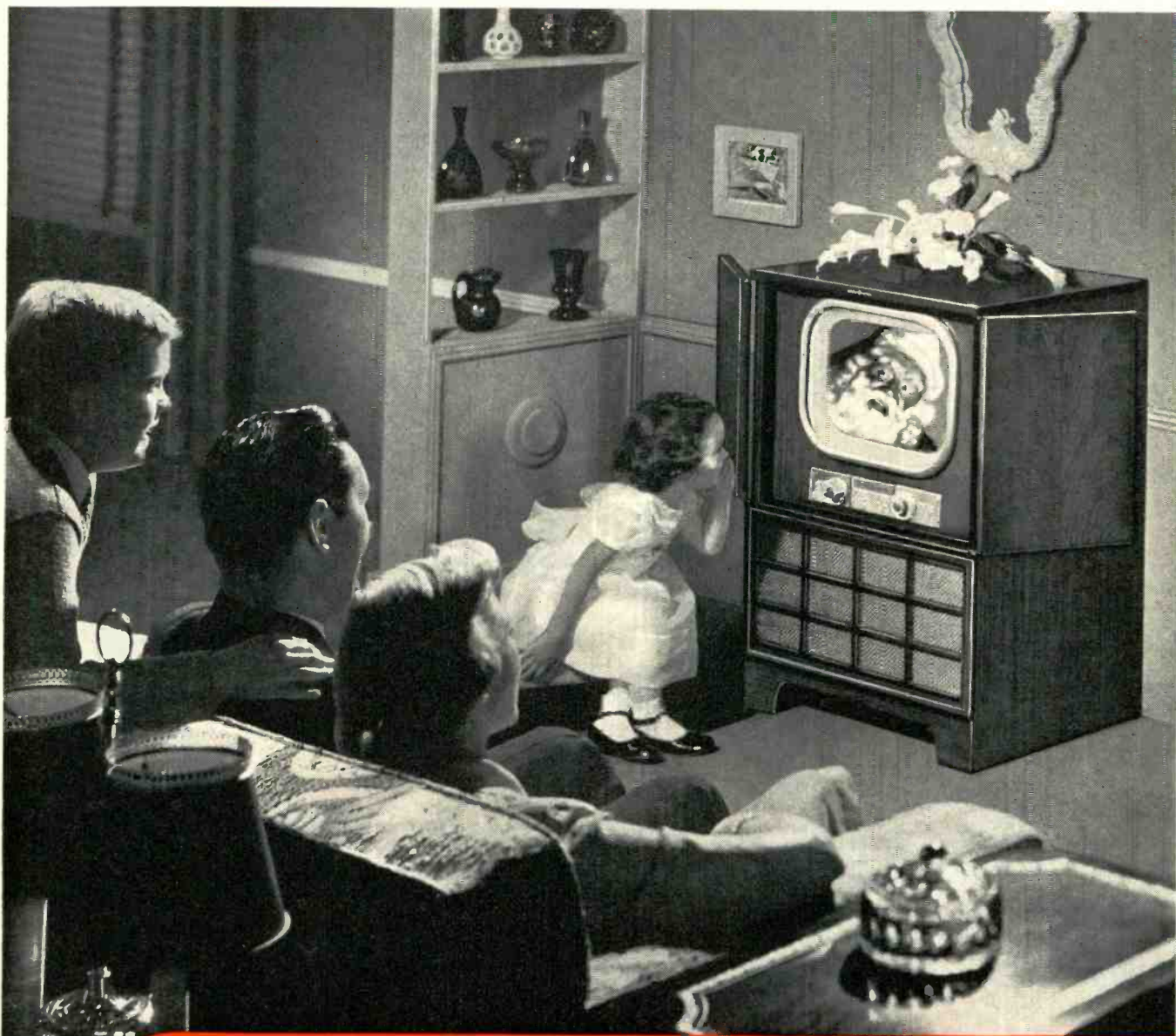

BLACK-DAYLITE TELEVISION

"Black Daylite"

● G-E Black-Daylite Television is distinguished both in name and in performance. Its outstanding picture quality and electronic excellence stem from many G-E advancements in picture tubes, circuits, components, and speaker design, which are combined exclusively in G-E Black-Daylite Television. For the whole exciting story, call your G-E TV distributor or write *General Electric Co., Receiver Division, Syracuse, New York.*

BIG-AS-LIFE, REAL-AS-LIFE PICTURES!



Now, see television brought to life in all its exciting realism! Advanced G-E rectangular black tube shows all the television camera sees. Sharper, clearer, more lifelike than ever—with close-ups actually as big as life!

EASIEST TUNING WITH AUTOMATIC SOUND!

No problem to tune a G-E. With G-E Automatic Sound, you just tune the picture—the sound is right every time! No retuning sound when changing stations.



NO JITTERS IN THE FAMOUS I-C CIRCUIT!



G.E.'s famous Inter-carrier circuit improves picture and sound quality even in fringe areas. There's new freedom from the howl and drift common in ordinary TV during tuning. You can even tune out most local picture interference without sound distortion.

TUBES AND CHASSIS MADE FOR EACH OTHER!

G-E electronic tubes of the most advanced types are used for long life and superb performance. Continuing research helps to make the tubes the finest any set can have.



MORE THAN TWICE AS POWERFUL!



G-E Dynapower speakers use Alnico 5, developed by G.E. and 2½ times more powerful than any magnetic material ever previously used in a speaker. Product of sound engineering, speakers by G.E. offer superb tone!

ANTENNA BUILT RIGHT IN... BUILT IN RIGHT!

Powerful, dependable G-E built-in antenna means that in most station areas you can plug in and immediately enjoy excellent reception with no outside antenna.



CABINETY OF RARE BEAUTY!



Triumph of America's foremost designers and craftsmen, G-E cabinetry inspires lasting pride of possession. Enduringly beautiful designs in both traditional and modern styles are distinguished in workmanship, fittings and finish. Veneered exclusively in choicest genuine mahogany or blond woods. All General Electric cabinets reflect the most discriminating taste.

You can put your confidence in—

GENERAL



ELECTRIC

The World's Finest

Finely decorated vase of blue jasper ware, manufactured in 1785 by Josiah Wedgwood; considered by many to be among the world's finest examples of the pottery-maker's art.

In pottery as in picture tubes, in art as in science, great names are born of great works. Today, as in the eighteenth century, Josiah Wedgwood is recognized as the producer of some of the world's finest pottery. Today too, men have come to know the name of Tel-O-Tube; a great name . . . born of a fine tube . . . the world's finest.



*The GREATEST Names In Television
PROTECT Their Names With Tel-O-Tube*

Tel-O-Tube Dealers Everywhere.
Write for the one nearest you.



TEL-O-TUBE Corporation of America

EAST PATERSON, NEW JERSEY

Sales Office: TEL-O-TUBE Sales Corporation, 580 Fifth Ave., New York 19, N. Y.

Wedgwood vase courtesy Metropolitan Museum of Art.

**For Leadership
in Research, Engineering, Design and
Manufacture of Television**

This important award has been conferred on Admiral for leadership in research, engineering, design and manufacture. It confirms a long-known fact . . . that Admiral TV is engineered to outperform any set, anywhere, any time . . . that Admiral gives you the clearest picture in television.



1951

Admiral TV



Beyond challenge today's greatest value. Complete with every wanted feature, including FM. Big 16" pictures . . . clear as the movies . . . free of glare . . . and *clear close up* . . . because of Admiral's revolutionary new "Filteray" tube. Super-power for outstanding performance even in "fringe" areas. Built-in directional Roto-Scope antenna. New, improved Triple Play phonograph. (33 $\frac{1}{3}$, 45 and 78 rpm.) Powerful Dynamagic radio, with FM, too . . . the famous Admiral "Ratio-Detector" FM that brings perfection in sound.

**MODEL 36R45 . . . with
16" "Filteray" picture tube
Triple Play phonograph
FM-AM Dynamagic Radio**

\$399⁹⁵

Ask your distributor about "Smart Set," Admiral's beautiful new magazine for the home. You'll find it a wonderful builder of good will and sales.

ON TV "Stop the Music," ABC, Thur., 8 PM, EST.
"Lights Out," NBC, Mon., 9 PM, EST.



Model 36R45—Walnut, Plus Tax and Warranty—Mahogany slightly higher. Prices slightly higher south and west, subject to change without notice.

"389 sold in 2



Model 516



CLOCK-RADIO

The World's Most Useful Radio!

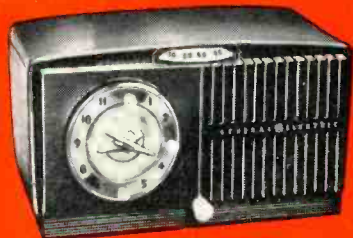

Model 515—Rich Congo brown. Also in alabaster ivory (Model 516 featured above), Persian red (Model 517) or porcelain white plastic (Model 518). All at one low price. **\$34.95***



Model 510—G-E "Wake-up-to-music" Clock-Radio in rich Congo brown. Also available in alabaster ivory plastic cabinet (Model 511). Same low price. **\$29.95***



Model 521—Deluxe dark mahogany and gold plastic cabinet. Also available in bleached mahogany and gold (Model 522). Both at the same low price. **\$39.95***

* Slightly higher. West and South. Subject to change without notice.

You can put your confidence in—

GENERAL

weeks - 4 to 1
over last year!"

says Jack Blackburn
Merchandise Manager,
Hart Furniture Company, Dallas, Texas

"Last year we thought a sale an hour was a record for G-E Clock-Radios, but during the first two weeks of February this year we averaged a sale every 15 minutes—4 to 1 over last year. More than ever this is the fastest selling radio we ever saw!"

Jack Blackburn

World's best selling radio

**No increase in prices
despite general upward trend.**

The fastest, easiest, cleanest seller in all radio is the General Electric Clock-Radio. It's America's #1 favorite—outselling all other brands combined. So spectacular, so amazingly useful are its features that every person in your trading area needs at least one—and every sale you make sells another! To all this, General Electric has added an unheard-of sales-clincher: all colors of each model sell at the same low price. Now watch sales zoom even higher! Better see your G-E radio distributor today or write to the *General Electric Company, Receiver Division, Syracuse, New York.*



ELECTRIC

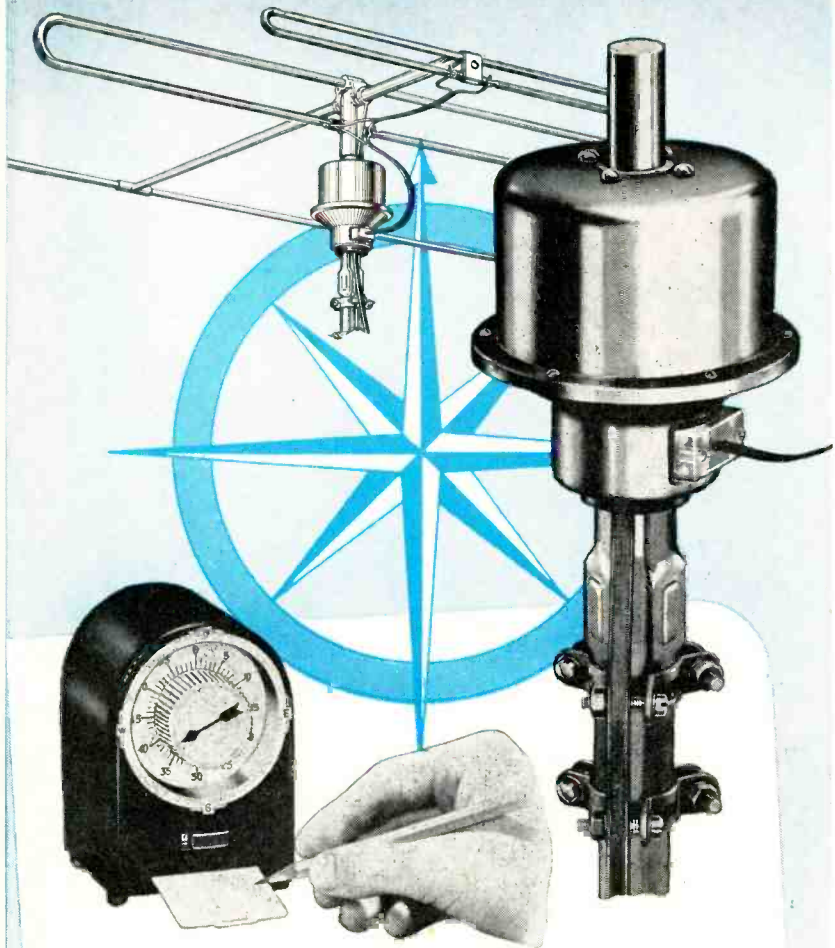

"AUTO-DIAL" TV ANTENNA ROTATOR

With *Automatic* TRAVEL ACTION

AMPHENOL takes pride in announcing the new "Auto-Dial" TV Antenna Rotator. It features an entirely new and different principle of rotator control called "automatic travel action," and represents the greatest single advance in antenna rotators.

There are no tiresome buttons or switches to hold while the antenna is turning. An effortless turn of the knob to the correct setting and "Auto-Dial" takes over. Automatically—just like magic—the antenna follows to point directly at the TV station—then stops!

So accurately does it perform that even a child can "log" antenna positions, accurately returning to them time after time. Rotation is in steps of 6 degrees, accurately calibrated on the indicator. Because of this important feature, servicemen can now determine whether an antenna is functioning properly, whether it has the required front-to-back ratio and whether it is properly located for the best possible picture.

FEATURES

- Completely Automatic—no tiresome buttons or switches to hold while antenna turns!
- Antenna Rotates Rapidly—one revolution every 22 seconds!
- Heavy-Duty Motor, Sturdy Construction—easily handles stacked arrays!
- Housing of cold-rolled steel, copper flashed and with attractive baked-on enamel finish!
- Neoprene Sealed at Factory Against Dirt and Moisture!
- Accommodates Mast Sizes from 3/4" to 2" Diameter!

See It At Your Jobber Or Write For Illustrated Folder
Another AMPHENOL Development For Your Greater TV Enjoyment

AMPHENOL

AMERICAN PHENOLIC CORPORATION

1830 SO. 54TH AVENUE

CHICAGO 50, ILLINOIS

Biggest
Deal
in
Needle
History

THE INCOMPARABLE
DUOTONE
*Star**
*BRAND
Sapphire



...with
brilliant
lucite
case!

Here's the BIG PROFIT deal!

It's a new Duotone exclusive! Famous Star* Sapphire, with a profit-proven record of over 1,000,000 sales, offered now with eye-catching giant lucite case and individual velvet lined cases at no additional cost. The handsome clear lucite jeweler's case lends brilliance to your counter, displays 18 Star* Sapphire needles in full view. Stock up now, for this liberal Duotone offer is limited to present stocks of display cases. Order yours today!

A NEW HIGH IN
DUOTONE
DEALER PROFITS!

Here's your cost—

18 STAR* SAPPHIRE
NEEDLES \$22.50

18 VELVET
LINED BOXES 0.00

BEAUTIFUL
LUCITE CASE 0.00

TOTAL \$22.50

Your Selling Price
is \$45.00—a Neat
Profit of \$22.50
with Reusable Lu-
cite Case Free!

Now Available! Sensational 3 Speed UNITONE
Sapphires on the Same Money-Making Basis!

Duotone brings you the needle everyone has been waiting for—the high quality hand-crafted Sapphire Needle that plays all types of records with full brilliance and tone. Packaged in individual cases and counter displays of beautiful, clear lucite as above. Sell UNITONE Needles for replacement in 3 speed machines.

SEE YOUR REGULAR DUOTONE SUPPLIER OR
WRITE DIRECT FOR COMPLETE INFORMATION



Canadian Representative: CHARLES W. POINTON, TORONTO, CANADA
Export Division: AD. AURIEMA, INC., NEW YORK CITY, N. Y.

CONTROL operations and PROTECT profits with the RIGHT FORMS and SYSTEMS!



Profit leaks, losses, mistakes, delays, disputes? Do they trouble you in your business? Then look for the answer in better, *simpler* forms and a positive, *simple* system which will give you complete, accurate and efficient records of every business transaction. You'll have adequate information at all times, a record system of control, real PROTECTION for your business... *and your profits!*

Selling to more than 800 franchised radio and television dealers, an Ohio appliance company controls its large and complicated business volume with a system

based on four fundamentals . . . immediate and accurate recording of each transaction . . . enough record copies for all concerned . . . the same record control for small items as for large . . . guaranteed consecutive numbering of all records. Standard Registers and combined, consecutively numbered Standard Forms produce these vital yet basically *simple* records . . . maintain constant control . . . save time and labor . . . prevent losses and protect profits.

Let BUSINESS AIDS Help You!

Case histories like these are told in detail by successful leaders in your line of business. They appear in BUSINESS AIDS, a fact-filled publication which is yours FREE. Write for it TODAY. And let Standard's nearest trained representative advise you about better and simpler forms and systems exactly suited to your needs: A FORM-FLOW REGISTER . . . UNIT ZIPSET or KANT-SLIP Continuous Forms (typewriter) System. Use the coupon below.

This Standard Electric Form-Flow Register, using multi-copy Standard Forms, records all the vital business facts you need at one writing, quickly and easily!

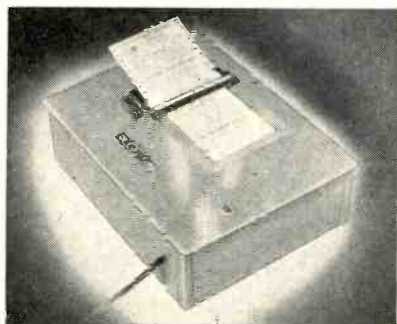

Standard Register

*Originator of Pin-Wheel Feed
and Marginally Punched Continuous Forms*

THE STANDARD REGISTER COMPANY, 1311 CAMPBELL STREET, DAYTON 1, OHIO
PACIFIC COAST: Sunset McKee-Standard Register Sales Company, Oakland 6, California.
CANADA: R. L. Crain Limited, Ottawa. GREAT BRITAIN: W. H. Smith & Son, Ltd., London.

MAIL THIS TODAY!

The Standard Register Company
1311 Campbell Street, Dayton 1, Ohio

Please send me, without obligation, BUSINESS AIDS, containing practical-experience articles on systems and forms as used in our business.

Name _____

Company _____

Street Address _____

City _____ Zone _____ State _____

Opening profitable new T-V areas.

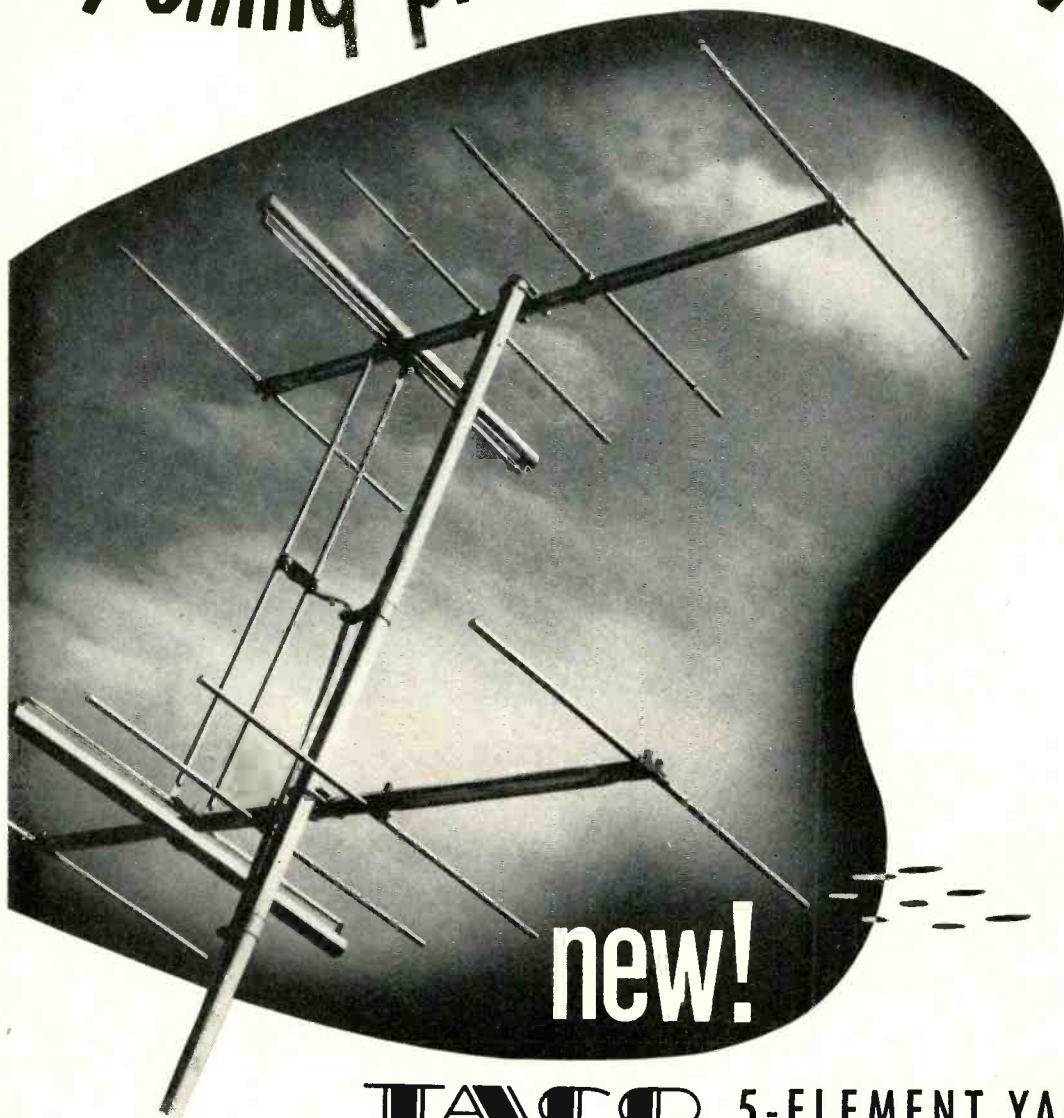

TACO 5-ELEMENT YAGI

OPENs TV sales areas beyond present limits. Picks up where 4-element antennas leave off in fringe area reception. Extra director steps up gain and minimizes interference. Two-diameter antenna element increases bandwidth.

Available for any channel—high or low-band.

High-band is "Click-Rig" assembled (snaps in place in less than 1 second). Low-band is TACO "Jiffy-Rig" assembled. Can be stacked for extra-high gain. Special harness available to permit use of one lead-in for several high and low-band antennas.



**SEND TODAY
FOR CATALOG 32.**

Complete technical information on antenna types. Curves and directivity patterns.

RADIO & ELECTRONIC EQUIPMENT

TACO

TECHNICAL APPLIANCE CORPORATION

SHERBURNE, N. Y. IN CANADA: STROMBERG-CARLSON CO., LTD., TORONTO 4, ONT.

3
speed
AUTOMATIC
PHONO-
GRAPH

LUXURIOUS
RADIO

most perfect **combination** yet!

the *JEWELLETTE*

by *Jewel*



The world's finest record changer and finest console-tone radio superbly styled into one magnificent combination! Perfect-balance tone arm with feather-light pressure assures longer wear for all size, all speed records. Truly an engineering triumph! Glorious true-timbre tone!

Webber Record Changer automatically plays all records . . . 7-, 10-, or 12-inch records at speeds of 33 1/3, 45 or 78 rpm . . . microgroove, "inside out" and home recordings, too

Clear selective reception . . . Super-heterodyne circuit with 2 I.F. transformers, 5 tubes including rectifier . . . AC operation. Built-in DURALOOP antenna. UL approved. Stunning cabinet of selected, matched veneer hardwoods . . . hand-rubbed to rich mahogany, walnut or blonde finish. Size 10" high, 16" wide, 20" deep.

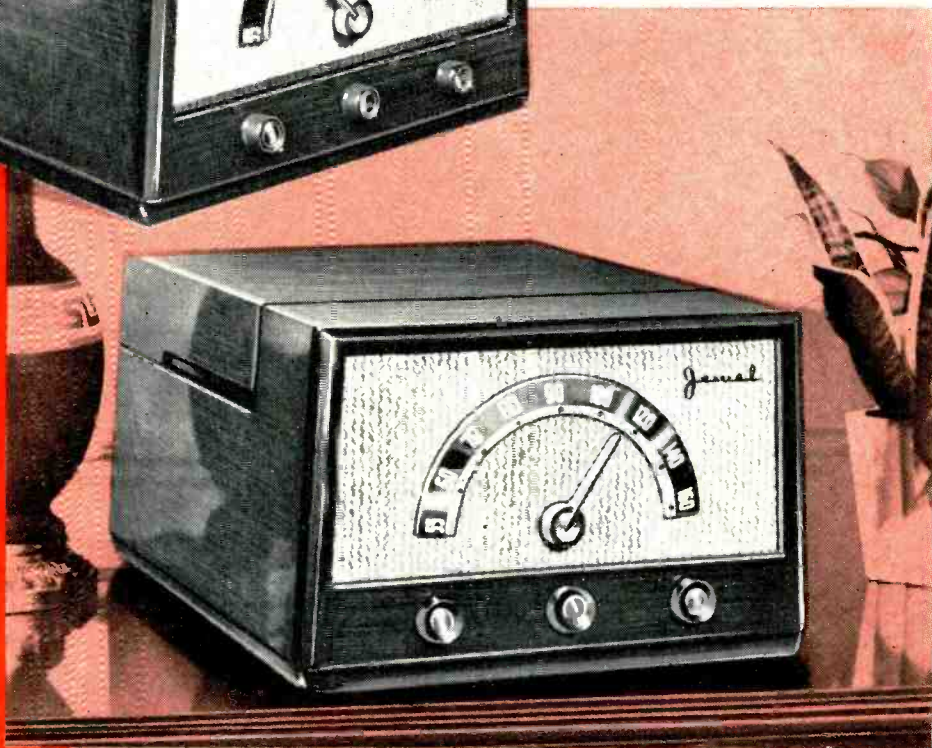

Jewel RADIO CORPORATION
10-40 45TH AVENUE, LONG ISLAND CITY, N. Y.

the *JEWEL* 5020 combination is the biggest seller of the year!

WEBSTER-CHICAGO'S **NEW**

Electronic Memory

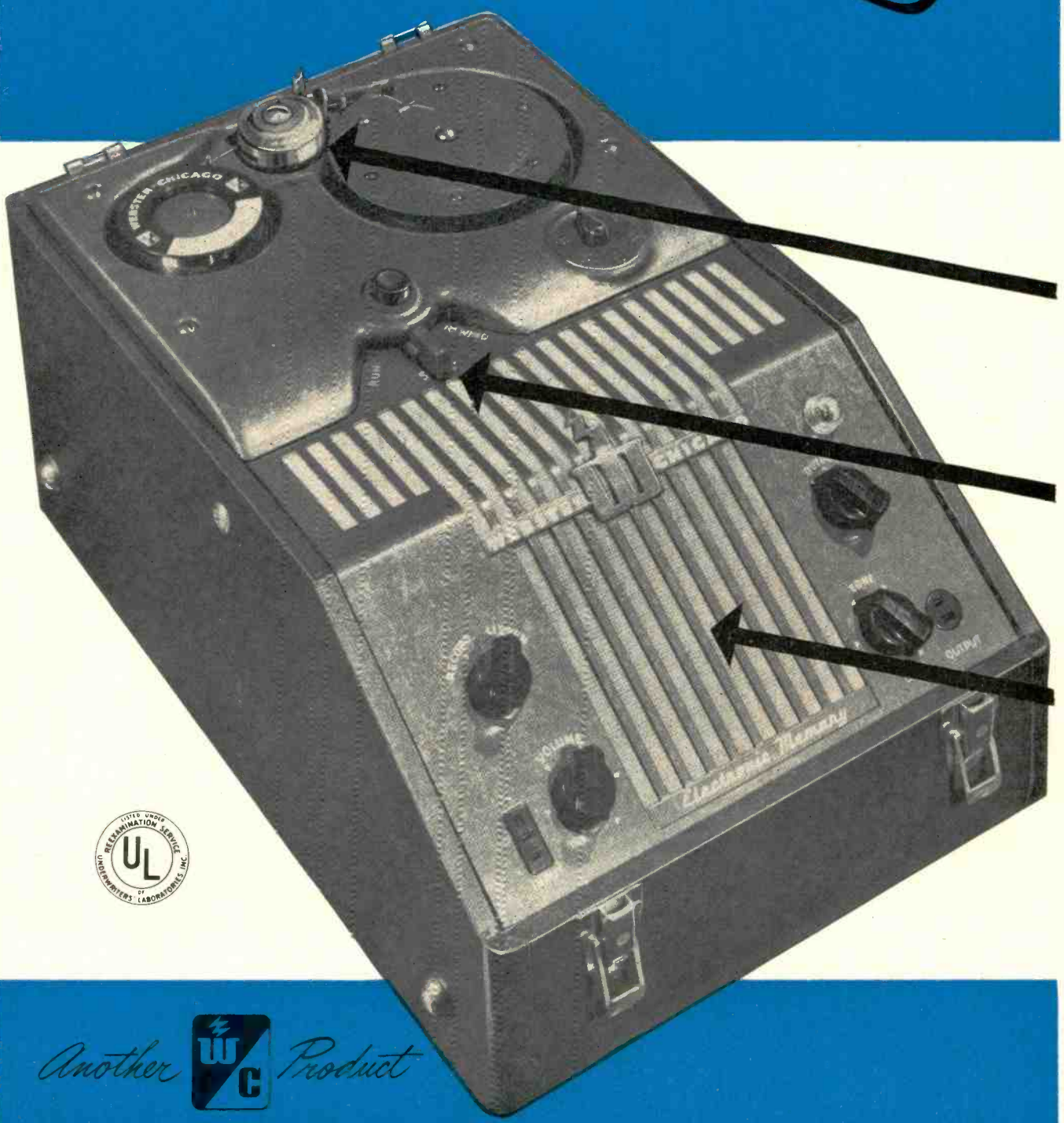

Another  *Product*

WIRE RECORDER **with**

- **New Non-Spill Recording Head**
- **New Positive-Control Lever**
- **New Console Response**

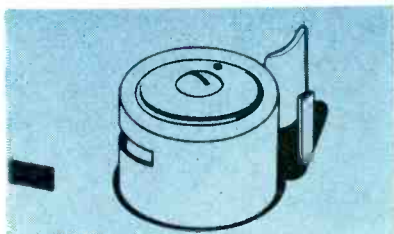

NON-SPILL RECORDING HEAD—An engineering triumph, it adds life to your wire and eliminates forever threat of spilled or tangled wire.

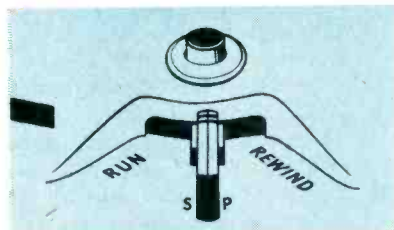

POSITIVE CONTROL LEVER—For ease of operation, integrated with a new braking system, it prevents operating errors.



CONSOLE RESPONSE—New sound chamber construction eliminates distortion and provides life-like "highs" and "lows."

THE demand for wire recorders will reach new heights between now and Christmas . . . and the Webster-Chicago Electronic Memory is the brand name your customers are going to ask for.

The NEW "288" is now rolling off the assembly lines at unprecedented rates and they are all equipped with the three latest developments in magnetic recording.

1-Non-Spill Recording Head, the fool-proof magnetic recording head that eliminates spilled and tangled wire.
2-Console Response for unequalled tone fidelity and
3-Positive Control Lever for new simplicity and ease of operation and quick, sure stop and start action. In addition, an integrated emergency braking system adds another control to assure the finest recording with a minimum of wear and maintenance.

Your customers are learning about these new features through a complete national advertising program—be sure to have your Webster-Chicago units on hand to meet their Christmas shopping needs.

WEBSTER-CHICAGO

5610 W. Bloomingdale Ave., Chicago 39, Ill.

the
best
picture
in
Television
is...

CLAROSTAT

**FOR CONTROLS,
RESISTORS, BEAM-BENDERS**

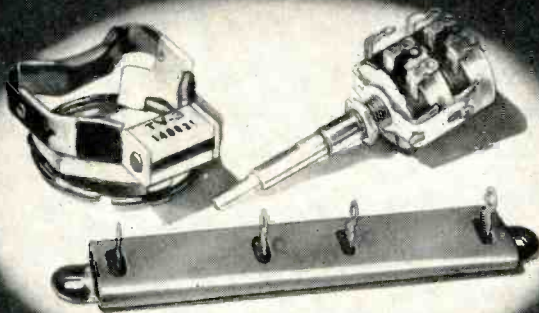

As "Big Business," television came suddenly. Just as suddenly, Clarostat was ready. Three decades of pioneering and specialization, backed by a plant second to none, assured TV designers and manufacturers of an outstanding selection of resistors, controls and resistance devices.

And when ion spot blemishes became a major problem, again Clarostat was ready with simpler and cheaper beam-benders.

Thus Clarostat products are already represented in over 5,000,000 sets and in countless radios in daily use. All because, for quality, uniformity, dependability, economy, it's CLAROSTAT.

Controls and Resistors

CLAROSTAT MFG. CO., INC. • DOVER, NEW HAMPSHIRE
IN CANADA: CANADIAN MARCONI CO. LTD., MONTREAL, P. Q., AND BRANCHES

CLAROSTAT



More Tubes..



for Clearer Pictures
and Greater
Distance Reception

Model 9121-B. Rich Mahogany
Styling—16" TV, FM-AM Radio,
3-Speed Phono.

better pictures ..



Proved over and over again!
Stewart-Warner Dyna-Power with
MORE TUBES gives you More Power,
Clearer Pictures, Greater Distance
Reception! Television that gives
your customers *more . . .* gives you
more! See your Stewart-Warner
distributor, *today!*

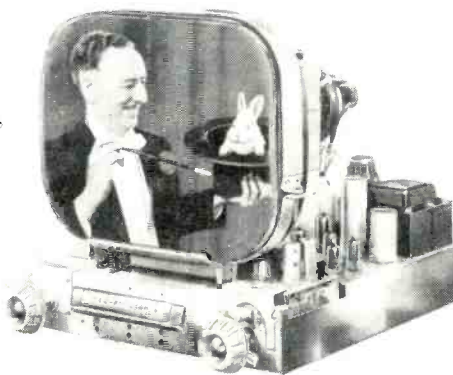

CHANNEL-EYE TUNING

Amazing lighted eye flashes call letters
UP TO MEET YOUR EYE! No stooping,
no squatting to dial!

DYNA-POWER CHASSIS

Only Stewart-Warner has it! **MORE
TUBES, MORE POWER** for the world's
finest picture!

STEWART-WARNER ELECTRIC • Division of Stewart-Warner Corp. • 1826 Diversey Parkway • Chicago 14, Ill.

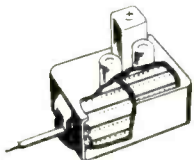

MIRACLE TURRET TUNER

STEWART-WARNER

See your
Stewart-Warner
Distributor Today!

You're IN Business

Here's the amazing leader of the line...
the sensational **UNIVERSAL 2-Speed Washer**

with over **30**
sales-clinching features

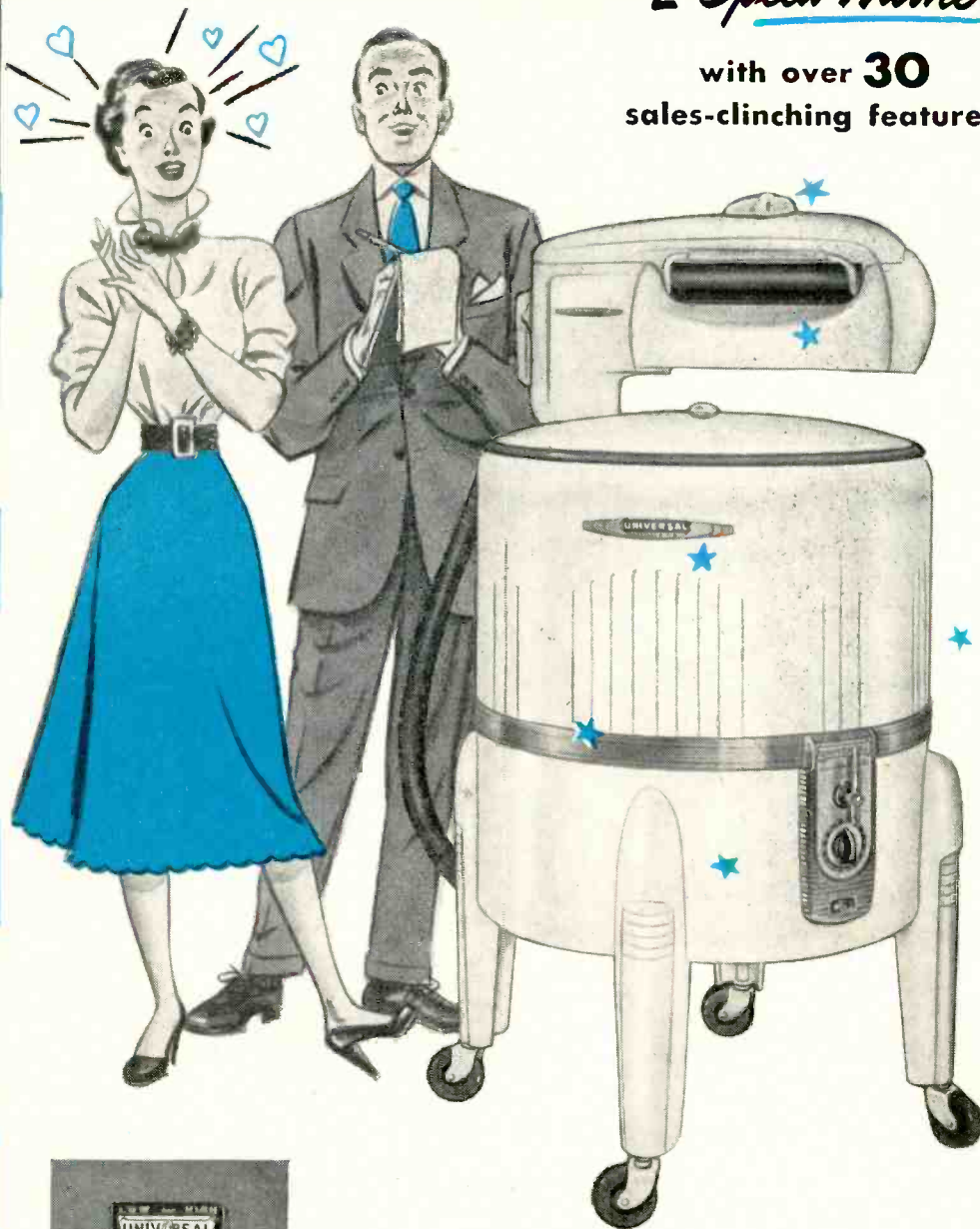

★ **PATENTED STERILATOR** with triple vanes designed to develop upper and lower water currents for thorough, gentle washing!



★ **"CONTROL-O-ROLL"** Wringer is super-safe. A light tug on clothes or touch of the release bar releases roll pressure instantly!



★ **PRESSURE CONTROL** on the wringer rolls can be set easily and quickly to the exact pressure for every type of fabric!

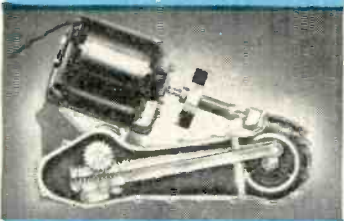

★ **EVERLAST MECHANISM** is life-time lubricated, with full-power direct drive—no belts, quiet rubber-cushioned motor.



OFF

★ **FINGER-FLUCK PUMP** control is operated by a touch of the finger to start the friction drive, quick-emptying pump when needed.



★ **SHOCK ABSORBER** cushion is heavy, live rubber between base frame and tub to absorb shock and lessen annoying vibration.



NEW EXCLUSIVE *Speedselector!*

Two-speed control in one washer! Low speed for fine fabrics... high speed for heavy laundry. A dramatic salesmaker that lets your customer control her washing! Plus... the famous Time-A-Matic Timer that takes the "watching" out of "washing"! Plus... Safe-T-Switch that shuts off the motor in case of overload or stalled wringer!

with UNIVERSAL'S BIG HOME LAUNDRY LINE!

FEATURE THE UNIVERSAL LINE . . . and you're set to do the kind of fast-moving, high-profit business that only the widest line of top quality home laundry equipment can develop for you.

WHY?

Because Universal gives you models exactly suited to your prospect's needs . . . priced to fit the fattest or the thinnest of budgets.

Because Universal gives you features that mean top value . . . a semi-automatic operation with the sensational Speedselector for 2-speed washing, super-safe Control-O-Roll Wringer, Floating Power, Sterilator Action . . . and many others.

You're "in" business with Universal . . . and the profitable chance to "sell up" on every sale. For the proof, ask your Universal Distributor about the success stories of dealers who are in business with the Universal line!

SINGLE SPEED WASHER—has same 9-pound capacity as top models, protected feeding zone and Select-a-Matic pressure control on the wringer. Built to give years of quiet, trouble-free service.



DELUXE SINGLE SPEED WASHER—with the famous "Control-O-Roll" super-safe six-position wringer. Has all the big 33 Universal features except the exclusive Speedselector and Time-A-Matic Timer.

POPULAR PRICE WASHER—price leader for the low-budget family who wants a high-quality washer. 7-pound capacity, patented Sterilator and many other features found only in top-priced washers.

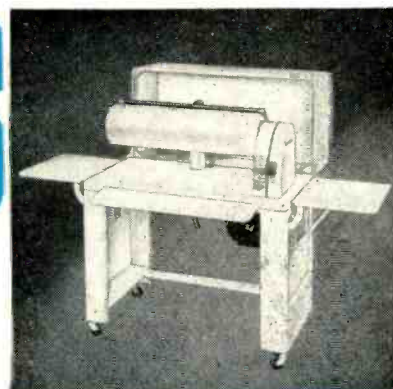

DELUXE 2-SPEED IRONER—with every important, top-quality feature for effortless, two-speed, heavy-duty ironing.



POPULAR PRICE IRONER—full-automatic, single speed, for the small, modern home where space is at a premium.

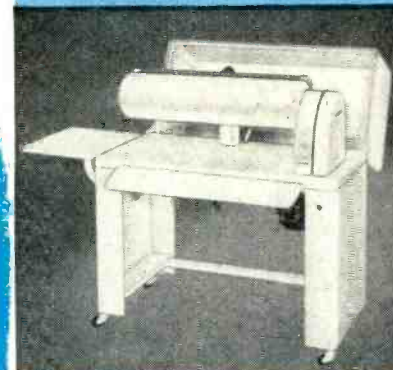

DELUXE SINGLE SPEED IRONER—unbeatable value for a feature-filled full-size quality ironer, attractively priced.



PORTABLE IRONER—large capacity with quality features at a fraction of the cost of a cabinet model. Weighs only 30 lbs.

UNIVERSAL

LANDERS, FRARY & CLARK, NEW BRITAIN, CONN.

Parts Show Committee

A fifteen-man Manufacturer-Distributor Advisory Committee for the 1951 Radio Parts Distributors Show was named recently by Jerome J. Kahn, show president, to consult with and advise the show management and committees making preparations for the annual all-industry sponsored show to be held in Chicago next May.

Herbert C. Clough, of Belden Mfg. Co., was named chairman of the committee, with the following members: William O. Schoning, Lukko Sales, Chicago; W. D. Jenkins, Radio Supply Co., Richmond, Va.; L. W.

Hatry, Hatry & Young, Hartford, Conn.; W. A. Wilson, Hughes-Peters, Inc., Columbus, O.; George Barbey, George D. Barbey Co., Reading; Lew Bonn, Lew Bonn Co., Minneapolis; H. L. Dalis, H. L. Dalis Co., New York; Sam Poncher, Newark Electric, Chicago; Charles Golenpaul, Aerovox Corp., New Bedford, Mass.; Milton Deutschmann, Radio Shack Corp., Boston; Walter W. Jablon, Espey Mfg. Co., New York; John Stern, Radio Electric Service Co., Philadelphia; Les Thayer, Belden Mfg. Co., Chicago and Robert C. Sprague, Sprague Electric Co., North Adams, Mass.

30th Birthday

Nationwide observance of broadcasting's 30th birthday, during National Radio and Television Week, Oct. 29 through Nov. 4, will include a review of the highlights of the industry's rise from 1920's crystal set to 1950's radio-TV-record player instruments. Listening and looking interest is at a peak for birthday celebrations, due to war and mobilization developments, national Congressional election contests, sports and other on-the-spot news events, and to efforts of broadcasters to assure set owners of "Never a Dull Moment."

News of the Reps

Lewis E. Sperry, executive secretary-treasurer of the Los Angeles chapter of the Reps, of Radio Parts Manufacturers, Inc., resigned recently because of ill health. The board of governors elected to his place Dr. Ralph L. Power, who handled chapter public relations the past year. A former professor of economics at USC, College of William and Mary and others, he has been in various radio circles since 1922.

Harry Appleton, 315 W. Pico Blvd., Los Angeles, has been elected to the Los Angeles chapter.

STATEMENT OF THE OWNERSHIP, MANAGEMENT, CIRCULATION, ETC., REQUIRED BY THE ACT OF CONGRESS OF AUGUST 24, 1912, AS AMENDED BY THE ACTS OF MARCH 3, 1933, AND JULY 2, 1946.

OF RADIO & TELEVISION RETAILING, published monthly at Philadelphia, Pa., for Oct. 1, 1950.

1. The names and addresses of the publisher, editor, managing editor, and business manager are: Publisher, M. Clements, Rumson, N. J. Editor, Orestes H. Caldwell, Catrock Road and Bible St., Cos Cob, Conn. Managing Editor, John L. Stoutenburgh, 564 Riverside Dr., New York, N. Y. Business Manager, M. H. Newton, 583 W. 215th St., New York, N. Y.

2. The owner is (if owned by a corporation, its name and address must be stated and also immediately thereunder the names and addresses of stockholders owning or holding one per cent or more of total amount of stock. If not owned by a corporation, the names and addresses of the individual owners must be given. If owned by a firm, company, or other unincorporated concern, its name and address, as well as those of each individual member, must be given.) Caldwell-Clements, Inc., 480 Lexington Avenue, New York 17, N. Y. M. Clements, O. H. Caldwell, Charles A. Petersen, Trustees, 480 Lexington Ave., N. Y. C. M. Clements, Trustee, Rumson, N. J. O. H. Caldwell, Trustee, Catrock Rd. and Bible St., Cos Cob, Conn. Charles A. Petersen, Trustee, 474 Senator St., Brooklyn, N. Y.

3. The known bondholders, mortgagees, and other security holders owning or holding 1 per cent or more of total amount of bonds, mortgages, or other securities are: (If there are none, so state.) None.

4. Paragraphs 2 and 3 include, in cases where the stockholder or security holder appears upon the books of the company as trustee or in any other fiduciary relation, the name of the person or corporation for whom such trustee is acting; also the statements in the two paragraphs show the affiant's full knowledge and belief as to the circumstances and conditions under which stockholders and security holders who do not appear upon the books of the company as trustees, hold stock and securities in a capacity other than that of a bona fide owner.

(Signed) ORESTES H. CALDWELL.
Sworn to and subscribed before me this 25th day of September, 1950.

BELLE M. PHILLIPS,
Notary Public New York and
Westchester County.

(My commission expires March 30, 1952.)

Note: This November and subsequent issues are being published from New York, N. Y.

PERFORMANCE COUNTS
wherever you are
when it's a *telrex*
CONICAL-V-BEAM
ANTENNA!

**AMERICA'S
OUTSTANDING
TELEVISION
ANTENNA**

Whether you are located 2 blocks or 200 miles from the TV transmitter, there's a CONICAL-V-BEAM antenna designed to outperform all others ... over 1,000,000 installations prove ... performance counts.

Conical-V-Beams are produced under Patent No. 2518297.

* REGISTERED TRADE MARK

telrex INC.
CONICAL-V-BEAMS ASBURY PARK 2, N. J.

AMERICA'S
STANDARD OF
COMPARISON

How Du Mont's extra tubes mean extra sales for you

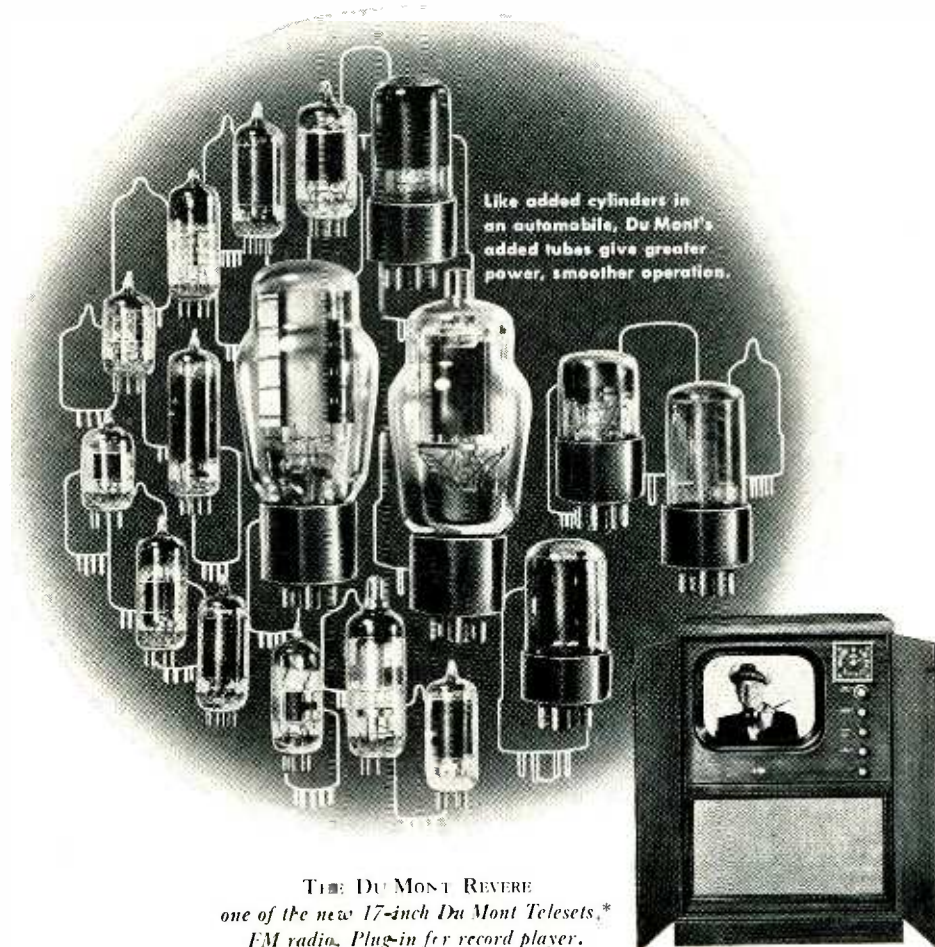

Like added cylinders in an automobile, Du Mont's added tubes give greater power, smoother operation.

THE DUMONT REVERE
one of the new 17-inch Du Mont Telesets,*
FM radio. Plug-in for record player.

As you know, a television set will work on 13 tubes. But it will work ever so much better on 21. And the resulting better performance means better business for you.

Even the lowest priced DuMont has 21 tubes, plus 2 rectifiers and the CRT. That's one reason why the DuMont picture is brighter and steadier; the focus sharper; the tone values more faithful . . . why you see no smear, roll-over or distortion . . . why DuMont owners *stay* satisfied.

It is DuMont manufacturing policy to use extra tubes — and oversize parts, finer materials, better shielding as well. The most advanced circuitry, the most rigid quality control in the entire industry are in every DuMont.

More models, more styles, with big 17- and 19-inch screens make up the DuMont line. DuMont—first with the finest in television—was always a dealer's prestige line. Now, more than ever, DuMont is a profit line too.

* Trade Mark

You'll do better with **DUMONT** Television's most coveted franchise
first with the finest in Television

Copyright 1950, Allen B. Du Mont Laboratories, Inc. Television Receiver Division, East Paterson, N. J., and the Du Mont Television Network, 515 Madison Ave., N. Y. 22, N. Y.

A glittering parade of Columbia Records Promotions for your profit!

Featuring famous name favorites—milestones of music—dramatic firsts
A consistent, continuous, concentrated merchandising program to help you sell!

FIRST
ANDRE
KOSTELANETZ

Gigantic
Tenth Anniversary
Celebration

NOW
SIR THOMAS
BEECHAM, Bart.

Focusing on the
Great Man of Music—on tour,
on the air, on Columbia
Records!

NEXT
AMERICA'S TWO GREATEST
ORCHESTRAS

The Philharmonic-Symphony
Orchestra of New York
The Philadelphia Orchestra

Beloved by listeners the country over—consistently led
by the world's greatest conductors—their Columbia
Records are continually on the best seller lists!
Columbia trains the spotlight on these famous or-
ganizations in a great promotion—backed by every
effective selling aid: radio spot announcements, pub-
licity, displays, mailing pieces, "good music" publica-
tion ads, co-op mat service, radio program plugs—a
full scale, all out sales campaign!

And Don't Forget These
Parallel Promotions!

"I CAN HEAR IT NOW"

Vol. III

"PIANO MOODS"

Every day—every week—every month—something new on

Columbia Records

First, finest, foremost in recorded music
originator of 33 $\frac{1}{3}$ LP records for uninterrupted listening pleasure



RETAILERS TELL WHY they favor Sylvania "Movie-Clear" TV

1951 Sylvania TV sets are the talk of the Television Industry. These sound-perfect, picture-perfect TV sets are hitting new "highs" in retailer acceptance. Take a good look at some of the many Sylvania dealer comments below. They tell exactly why more retailers every day are selecting the new Sylvania 1951 TV sets as their top-selling favorites.

✓ For Top Demonstrations in Poor Reception Areas

William J. Imblum of the Bill Imblum, General Appliance Service, says . . . "our store is in a bad location for television reception. We have quite a bit of interference on all sides, but the reception and clearness of picture we get here on the 1951 Sylvania sets is almost unbelievable!"

✓ For Steady High Level Profits

J. A. Wagner, owner of the Wagner Appliance Co., has this to say . . . "Sylvania will be second in dollar volume among our major lines, and first, by a very considerable margin, in both gross and net profits for the year."

✓ For Owner Pride and Satisfaction

Edward A. Weitz of Weitz Radio and Home Appliances, says . . . "I definitely try to sell Sylvania in preference to

ANY other brand, and can honestly say that all my customers are justly proud of their sets, and in many cases have sent friends to my store for a SYLVANIA."

For Making Satisfied Customers "Assistant Salesmen"

Tom McNamara, owner of Modern Science Products, says this . . . "Accordingly, we are now favored with quite a few leads for new sales from our old satisfied customers."

✓ For Easy Sales on Home Demonstrations

R. D. Matheny, Sales Manager of the Television Division of Allegheny Products, Inc., says . . . "Sylvania has consistently out-performed and out-sold the other six brands. In both the metropolitan and fringe areas, the 1951 Sylvania gives a clear, concise picture which indeed sells itself."

**YES, ANY WAY YOU LOOK AT IT—
YOUR PROFIT CHOICE IS SYLVANIA**



SYLVANIA ELECTRIC PRODUCTS INC.

RADIO & TELEVISION DIVISION

254 Rano Street, Buffalo 7, New York

*TRADEMARK

The Service
Managers of
Admiral
ZENITH
Hallicrafters
Motorola
all recommend the

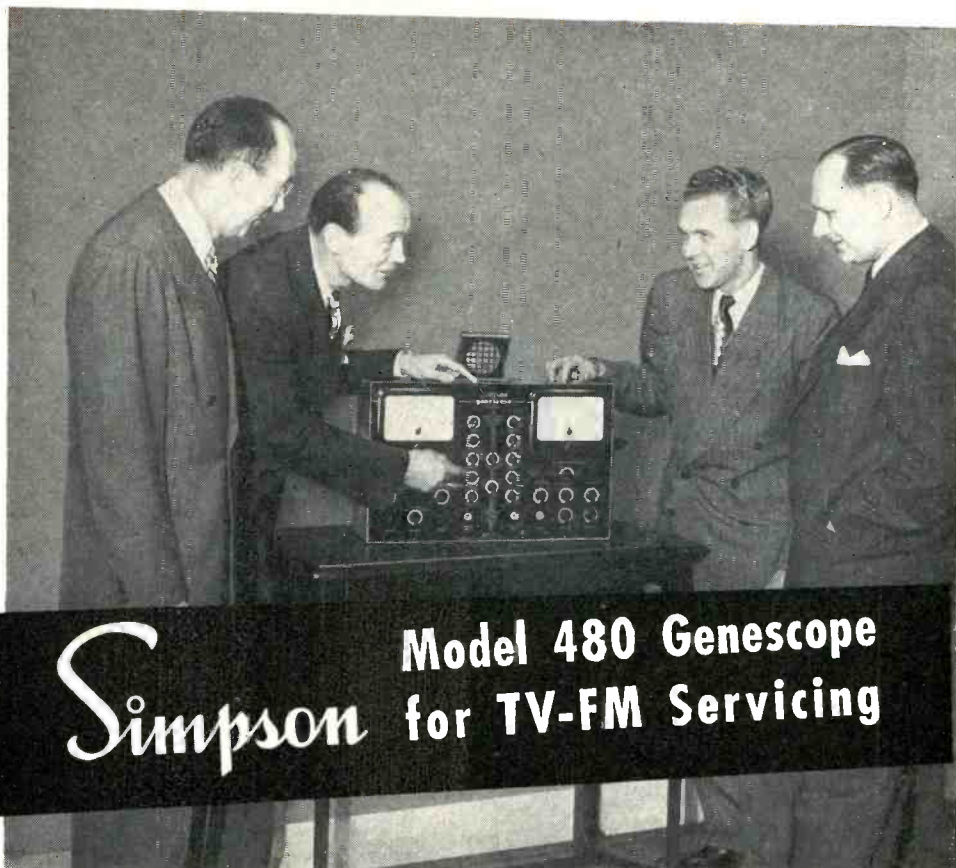

**Model 480 Genescope
Simpson for TV-FM Servicing**

Max Schinke—ADMIRAL Frank Smolek—ZENITH Ed Croxen—HALLICRAFTERS Tim Alexander—MOTOROLA

• These four well known general service managers prefer the Simpson Model 480 Genescope for their FM and TV servicing.

For proper testing, servicing, and alignment of all TV and FM receivers, the Simpson Model 480 Genescope is the ideal instrument, leading general service managers agree.

These service managers know that modern FM and TV development and servicing demands test equipment made to the most exacting standards. They prefer the Simpson Model 480 Genescope because it is the most accurate, flexible, and convenient instrument available.

The Genescope is ruggedly built to give many years of trouble-free, accurate service.

In addition to providing all necessary signal sources, the new Simpson Genescope includes a high sensitivity oscilloscope of unique advanced design, complete in every detail. Equipped with a high frequency crystal probe for signal tracing. AM and FM oscillator sections provided with large, easy to read dials with 20:1 vernier control and 1000 division logging scales. *Revolutionary, ingenious, exclusive* output termination provides for various receiver impedances, either direct or through an isolating condenser. Step attenuator for control of output. Size 22" x 14" x 7 1/2". Weight 45 lbs. Shipping Weight 54 lbs.

DEALER'S NET PRICE complete with Test Leads and Operator's Manual \$375.00

**THESE RANGES SHOW HOW MUCH THE
SIMPSON GENESCOPE CAN DO FOR YOU**

**FREQUENCY MODULATED
OSCILLATOR**

- Band A: 2-120 megacycles
- Band B: 140-260 megacycles
- Sweep width variable from zero to 15 megacycles
- Sweep rate 60 cycles per second
- Specially designed frequency sweep motor
- Continuously variable attenuator
- Crystal calibrator: 5 megacycles \pm .05%
- Audio Oscillator 400 cycles
- Output Impedance 75 ohms
- Step attenuator for control of output

**AMPLITUDE MODULATED
OSCILLATOR**

- Band A: 3.3-15.6 megacycles
- Band B: 15-75 megacycles
- Band C: 75-250 megacycles
- 30% modulation at 400 cycles or unmodulated
- Continuously variable attenuator
- Visual method of beat frequency indication

OSCILLOSCOPE

- Vertical sensitivity: 35 mv per inch
- Horizontal sensitivity: 70 mv per inch
- Linear sweep frequency: 3 cycles to 60 kilocycles
- 60 cycle sine sweep
- Frequency essentially flat to 200 KC. usable to over 3 megacycles

**THE SIMPSON MODEL 479 TV-FM
SIGNAL GENERATOR**

Exactly the same circuits, ranges and functions as the Model 480, described above, with the exception of the oscilloscope. Size 17" x 14" x 7 1/2". Weight 34 lbs. Shipping Weight 40 lbs.

DEALER'S NET PRICE with Test Leads and Operator's Manual . . . \$245.00



Simpson
INSTRUMENTS THAT STAY ACCURATE

SIMPSON ELECTRIC COMPANY
5200 WEST KINZIE STREET • CHICAGO 44, ILLINOIS
In Canada, Bach-Simpson, Ltd., London, Ont.
Phone: COLUMBUS 1-1221

Westinghouse

**SCORES TWICE *
FOR TELEVISION DEALERS**

Betty Furness is rated tops among television sales people. Her convincing demonstrations of Westinghouse Television Studio One will have pre-sold prospects in your own market with 40 million consumer impressions by Christmas, this season alone.



The Berkeley, Model 627K16
Mahogany console with doors—16 in. tube



* WITH THE
LEADING FEATURE OF THE YEAR
SINGLE DIAL CONTROL
provides Sure-Sales demonstrations on new tuning ease *on every model* in the line, plus many brilliant new circuit features.

* WITH TV'S TOP DRAMATIC SHOW
STUDIO ONE
provides the greatest audience of any television set manufacturer. Develops business for Westinghouse dealers in their own communities with actual TV sales demonstrations reaching 94% of total television homes. No other show has scored so effectively with both critics and the trade.

FLASH !!!

Beginning in January, Westinghouse STUDIO ONE will be seen by more than 7,000,000 viewers weekly, by far the largest audience of any set manufacturer.

YOU CAN BE **SURE** ...IF IT'S **Westinghouse**

WESTINGHOUSE ELECTRIC CORP. • TELEVISION-RADIO DIVISION • SUNBURY, PENNSYLVANIA

www.americanradiohistory.com



14-inch Rectangular Screen. Model 662. Most compact set made. Long Distance Circuit performs where others fail!

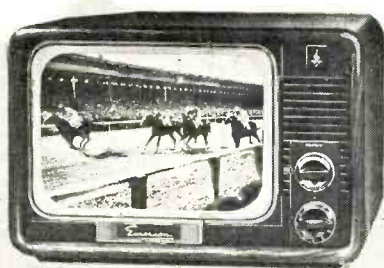

16-inch Rectangular Screen. Model 663. Magnificently styled, deluxe mahogany cabinet. 1951 Value Leader!



19-inch Picture, Deluxe Mahogany Console. Model 669. Emerson's "millionaire" television priced for the millions.

16-inch, FM-AM Phonoradio. Model 666. Complete home entertainment at an unbeatable price.

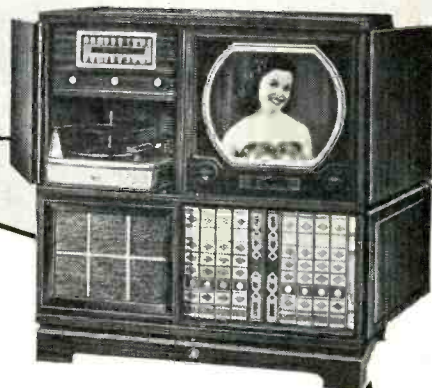

WORLD'S CLEARER TELEVISION!
Only Emerson has the NEW
FULL-SCREEN-FOCUS and
BLACK-MAGIC-CONTRAST

**They STAY
SOLD With
Emerson**

**Sensational New 1951 Emerson
Values Selling Like Wildfire! Unrivaled
Emerson Performance Keeps Customers Sold,
Multiplies loyal Followings for Dealers.**

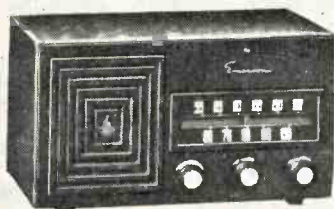

Superb, Super-Powered Compact. Model 641. Sealed Unit Alnico 5 Speaker. Supersensitive, Long Distance reception.

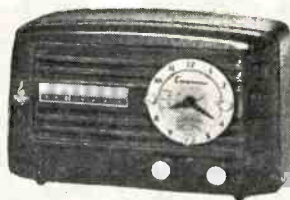

Automatic Clock Radio. Model 671. The finest money can buy at an amazing volume price!



3-Way Portable. Model 646. America's fastest-selling set. Maroon, Green, Saddle Tan, Ivory.

Every 5 Seconds Someone Buys an Emerson Television or Radio Receiver

Clearly America's Best Buy!

Emerson Radio & Phonograph Corporation • 111 Eighth Avenue, New York 11, N. Y.



BIGGEST POTENTIAL MARKET IN THE BUSINESS!



- 37 million American homes are prospects for automatic electric dishwashers and less than 2% of the market has been saturated.
- Good Housekeeping Magazine surveys indicate 32.8% of these homemakers are actually *planning to buy an automatic electric dishwasher now.*
- More families are buying Hotpoint dishwashers *each week* than in our *best pre-war year.*

HOTPOINT FIRST IN DISHWASHERS!

★ **FIRST in Sales** . . . Hotpoint's sales of electric automatic dishwashers far exceed those of any other manufacturer.

★ **FIRST with Front Opening** . . . Hotpoint was the first to offer an automatic dishwasher with front opening—for greater ease in loading—for uninterrupted work surface—for convenient installation under counters or cabinets—for use of overhead, down-rinsing spray.

★ **FIRST with Electric-heat Drying** . . . Hotpoint was the first to provide electric-heat drying with its forced hot air circulation for faster drying with clean, hot air.

★ **FIRST in Customer Demand** . . . Hotpoint Automatic Dishwashers rank first among dishwashers wanted most by most people. You can get your share of the profit in this fastest growing appliance market with low investment. The turnover is rapid and there are no trade-ins.

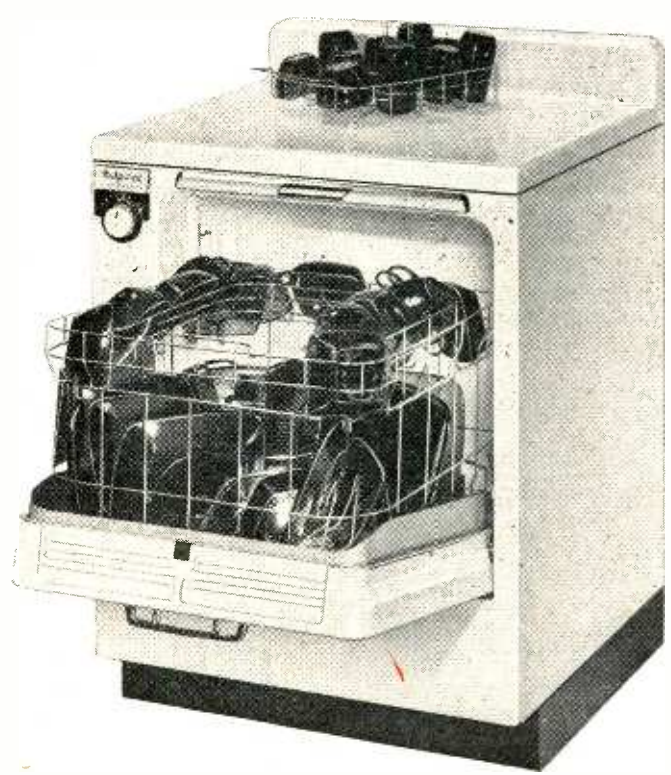

Hotpoint Full-Line Leadership

The Hotpoint line includes every major electric appliance for kitchens and home laundries—each an outstanding leader in its field. Talk to your Hotpoint distributor about the Hotpoint Full-Line Franchise.

Switch to Hotpoint! FOR FULL LINE LEADERSHIP

RANGES • REFRIGERATORS • DISHWASHERS • DISPOSALLS® • WATER HEATERS • CABINETS
FOOD FREEZERS • AUTOMATIC WASHERS • CLOTHES DRYERS • ROTARY IRONERS

HOTPOINT, Inc.
(A General Electric Affiliate)
5600 W. Taylor St., Chicago 44, Illinois

 **Television at its
unquestioned finest
for your holiday trade**



Arvin Model 4162CM

\$349⁹⁵
plus tax

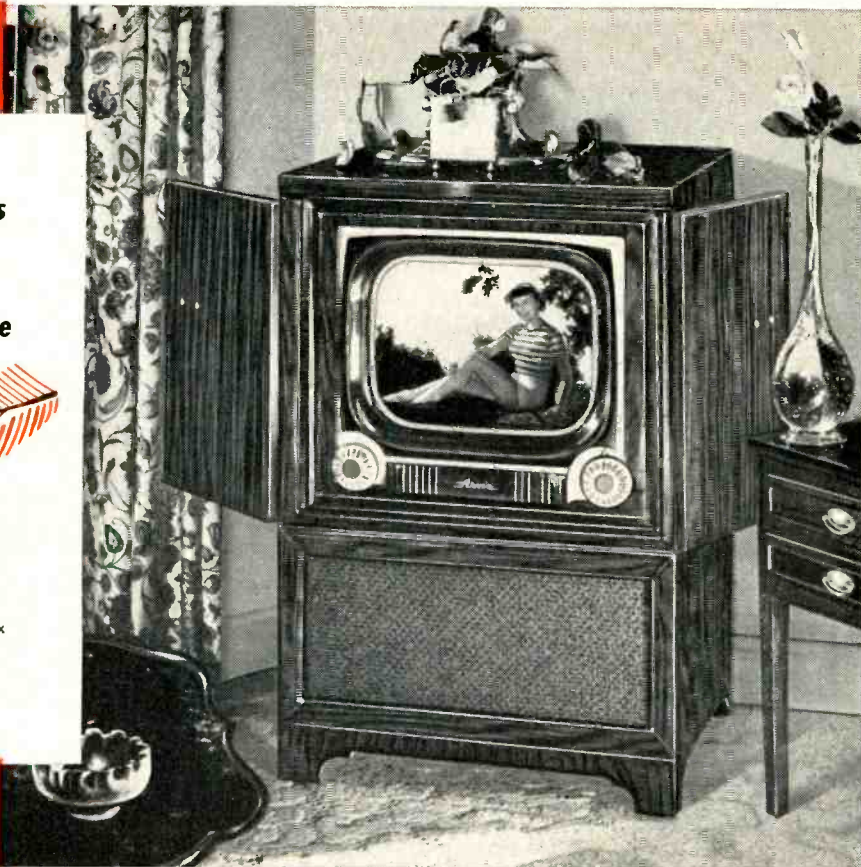

 **Show the TOP of the Arvin Line**

for prestige...for profit!

THIS Arvin Custom Console Set is the set for those customers who insist on the best but don't want to pay through the nose for top quality!

Model 4162CM is obviously Fine Furniture with a capital "F" — superb imported mahogany veneer with finish-o'-gold and sparkling crystal lucite appointments. And look at this list of performance features:

- Rock-solid stability for exciting fringe area reception!
- Gated automatic gain control combats interference!
- Sensitivity compensation for local reception without overload!
- Straight AC circuit, 26 tubes including rectifiers!
- Rich Velvet Voice tone system!
- Powerful electro-dynamic speaker!
- Continuously variable tone control!
- Two-thirds doors, hinged to swing flush to sides!

*Also in blond finish, Model 4162CB, \$369.95
Other models from \$129.95. Prices subject to change
without notice.*

Phone, wire, or write for distributor's name!

ARVIN INDUSTRIES, Inc., Columbus, Indiana
(Formerly Noblitt-Sparks Industries, Inc.)

Arvin TV
 **VISIBLE VALUE**
You can see the difference!

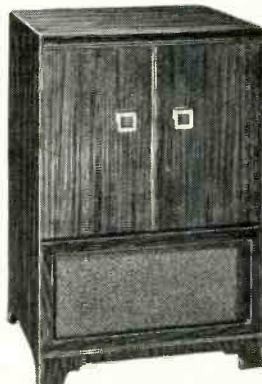

**Free newspaper mats and
powerful displays to help you
reap greatest benefit from
Arvin's national advertising to
millions of readers!**



Santa Claus points to

The Gift Item of the Year!

WILCOX-GAY RECORDETTE G₃



3-SPEED

★ RECORDER

★ RADIO

★ PHONOGRAPH

PLAYS ALL THREE SPEEDS
RECORDS ALL THREE SPEEDS
PORTABLE Weighs only 18 lbs.

RECOMMENDED
RETAIL PRICE

MODEL IJII **\$99.95**

COAST TO COAST

THE CHOOSY SHOPPER WILL PICK RECORDETTE BECAUSE . . .

- **IT'S THE PERFECT HOUSE GIFT**
The entire family enjoys this versatile instrument
- **IT'S THE UNUSUAL GIFT SELECTION**
Ideal for the hard-to-please individual
- **IT'S THE "SMART" GIFT FOR THAT SPECIAL PERSON**
A product of exquisite design and eye appeal
- **IT'S THE ENDURING GIFT THAT PLEASES**
The gift that is both entertaining and educational

ALERT MERCHANTISERS ARE PLANNING BIG RECORDETTE PROMOTIONS BECAUSE OF:

- **OVER THE COUNTER SALES**
No delivery problems — No service problems
- **QUICK TURNOVER**
Recordette is a fast seller with a wide market
- **AVAILABLE MERCHANDISE**
Wilcox-Gay production is geared to volume sales
- **TRAFFIC ITEM**
Recordette has the appeal that creates traffic

**PLAN THIS EXCITING PROMOTION
FOR THE YEAR'S BEST PROFIT OPPORTUNITY**

WILCOX-GAY
HOLIDAY PROMOTION
It's Terrific!

WILCOX-GAY CORPORATION, CHARLOTTE, MICHIGAN

SEND WILCOX-GAY PROMOTION TABLOID
for the complete Recordette Selling Program

NAME _____
FIRM _____
ADDRESS _____
CITY _____
STATE _____

New

Capehart CX-33 Chassis

**CUTS
SERVICE PROBLEMS
TO THE
VANISHING POINT!**

**Designed for the Serviceman, the CX-33 Gives
New Standards of Performance Never Before
Achieved in the Television Industry!**

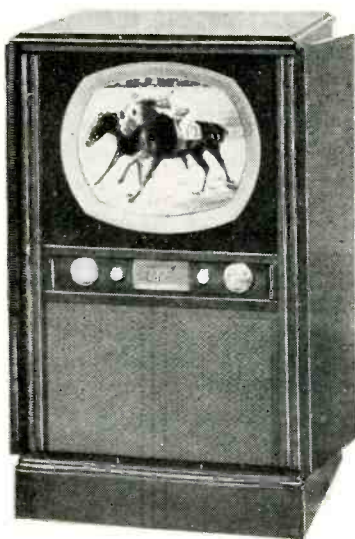

THE NEW CAPEHART CX-33 chassis is not only super-powered for long-distance reception, interference-free operation, and greater sensitivity—but it also brings new standards of service-free operation!

Even the normal servicing problems are tremendously simplified. Easy accessibil-

ity is provided—to secondary controls with a removable front plate—a safety door in the rear — Focusing control — Polatenna phasing switch.

With the new CX-33 chassis you cut overhead to the bone, raise your net profit to new highs!

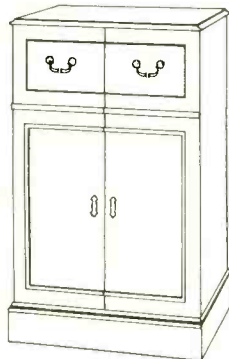

←The CAPEHART "William Penn." 16-inch picture tube. "Synchro-Sound" provides perfect synchronization of picture and sound. Capehart Symphonic-Tone. Mahogany Veneer English 18th Century cabinet with authentic hardware. Full doors fold flush against sides.

The CAPEHART "Nantucket." → 16-inch rectangular tube gives full-picture to edge of screen. Capehart Symphonic-Tone System is perfectly synchronized with picture. Handsome, clear line modern styling in rich dark mahogany veneer. Ideal for small home or apartment.



CAPEHART-FARNSWORTH CORPORATION, Fort Wayne 1, Indiana

An Associate of International Telephone and Telegraph Corporation

One of the great
Christmas Records
of all time!

THIS
DECCA
RECORD
Available on 45 RPM—78 RPM

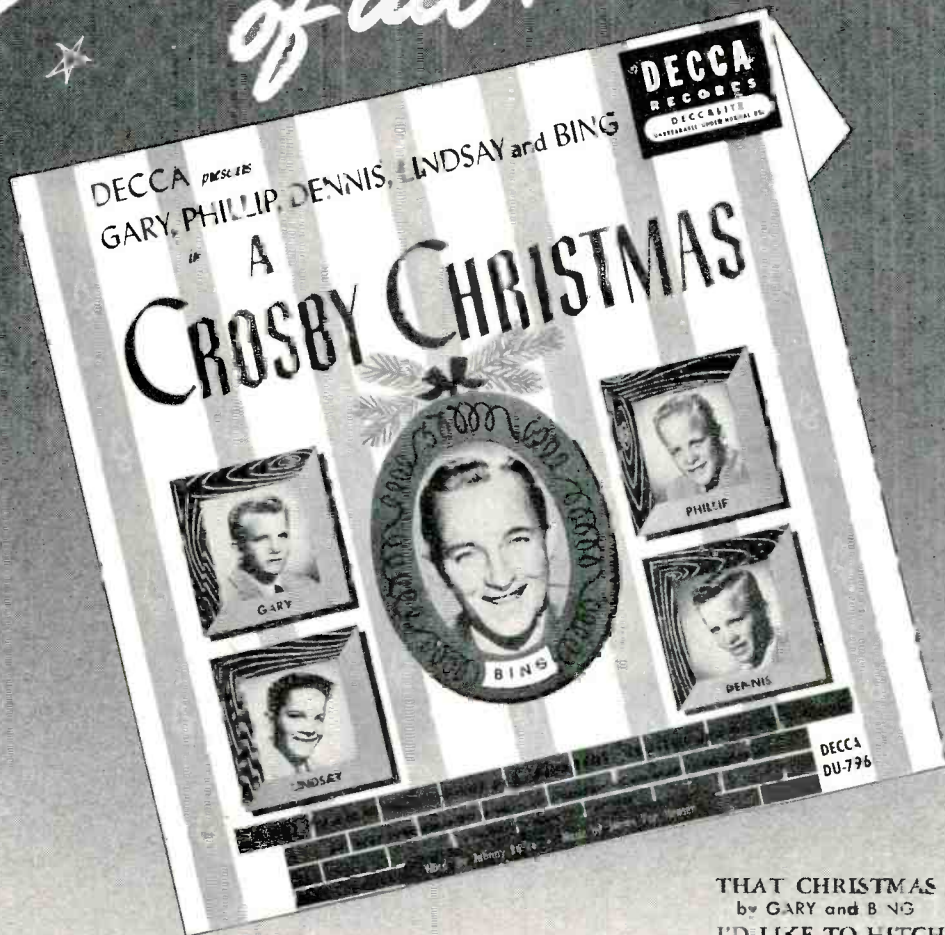

A CROSBY CHRISTMAS

GARY, PHILLIP, DENNIS LINDSAY and BING CROSBY
with JEFF ALEXANDER CHORUS and JOHN SCOTT TROTTER and his Orchestra

THAT CHRISTMAS FEELING — Sung
by GARY and BING
I'D LIKE TO HITCH A RIDE WITH
SANTA CLAUS — Sung by LINDSAY
THE SNOW MAN — Sung by PHILLIP and
DENNIS

Words by Johnny Burke.
Music by James Van Heusen.

DECCA DU-796—One 10-in. Unbreakable* 78 rpm
record in decorative envelope—\$1.00 plus tax.

*DECCALITE—Unbreakable under normal use.

DECCA 1-134—One 45 rpm unbreakable record in
decorative envelope—95¢ plus tax.

DECCA 27249—One 10-in. 78 rpm record—75¢ plus
tax.

America's Fastest Selling Records



24 inch television

by **STROMBERG-CARLSON**

huge 24-inch "black" tube →

hand-rubbed Honduras mahogany veneer cabinet →

3-speed automatic record changer →

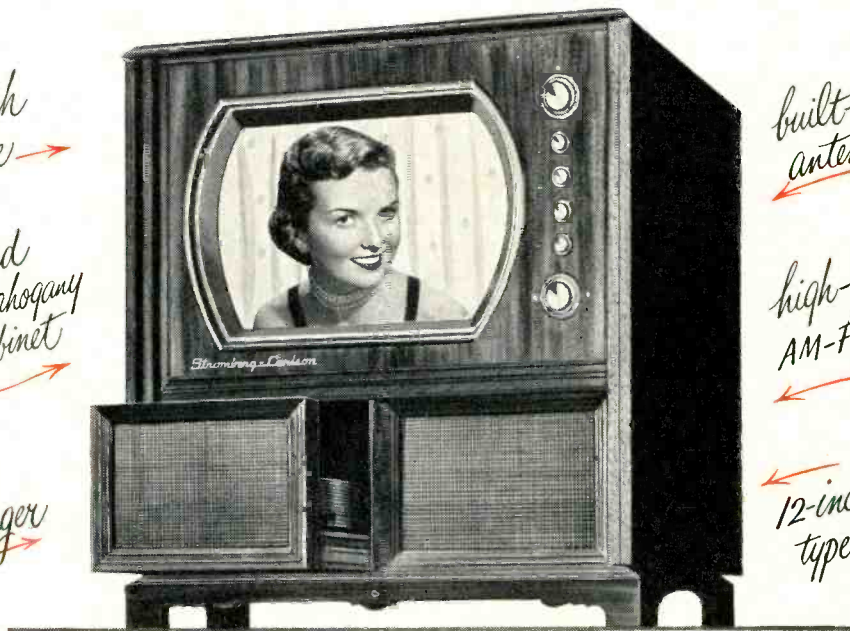

built-in antennas ←

high-fidelity AM-FM radio ←

12-inch concert-type speaker ←

The New Stancliffe

Imagine a screen more than three times as wide as this advertisement—and you have an idea how tremendous this new Stromberg-Carlson picture is! 356 square inches of bright, clear television!

Only 46" high, 38" wide and 26" deep, this amazingly compact cabinet is purposely designed for home use. It is also an ideal receiver for schools, clubs, auditoriums—any place where large groups gather.

The Stancliffe demonstrates again—in Big-as-Life television, "There is Nothing Finer Than a Stromberg-Carlson."



It's a complete home entertainment unit! . . . Huge 24-inch Hi-Contrast "black" tube—356 square inches! . . . Exclusive tuner brings brightest, clearest, steadiest pictures—even in difficult areas . . . Exquisite tone from famous Stromberg-Carlson audio system and full-floating, 12-inch, concert-type speaker . . . High-fidelity AM-FM radio, 3-speed automatic record changer . . . Built-in antennas . . . Beautiful period cabinet, decorator-designed, completely hand-rubbed, two full-length, full-swing doors . . . In Honduras mahogany veneers.

"There is nothing finer than a STROMBERG-CARLSON"®

Stromberg-Carlson Company, Rochester 3, N. Y.—In Canada, Stromberg-Carlson Co., Ltd., Toronto

RADIO & TELEVISION RETAILING

Including "RADIO & TELEVISION,"
"RADIO & TELEVISION TODAY,"
and "ELECTRICAL RETAILING"

O. H. CALDWELL, Editorial Director



M. CLEMENTS, Publisher

AS IN FORMER YEARS, BILLS PROPOSING the elimination of tax exemption privileges enjoyed by cooperatives in competition with private business will be introduced in some state legislatures next year. Such measures will continue to run into opposition from the powerful representation in state lawmaking bodies, however; are unlikely to be adopted on widespread basis.

BUILT-IN ANTENNAS FOR TV sets, on the market now for well over a year, have eased the way for many a set sale, where customer was leary of installation costs, or was not allowed a roof antenna. Nevertheless, many installers (and even some set makers) still say that if the customer wants the best kind of picture possible, he must have an outside, orientable job. Dealers should not hesitate to tell customers that built-in antennas, unlike Duz, do not do everything.

FACTORY SALES OF STANDARD-SIZE VACUUM CLEANERS in the first seven months of this year were 23 per cent ahead of the same period in 1949, aggregating 1,975,145 units, compared with 1,605,020, according to industry-wide figures announced by the Vacuum Cleaner Manufacturers' Association.

PROPOSALS FOR A NEW UNFAIR TRADE PRACTICES act in New York and for stronger measures in Kentucky and Rhode Island were unsuccessfully introduced in current-year legislative sessions, but may be revived. Other states in which new or stronger acts may be pushed include Alabama, Arkansas, Colorado, Florida, Idaho, Illinois, Michigan, Oklahoma, South Dakota and Texas.

ALL OVER THE COUNTRY, TV IS RESPONSIBLE for changing the "looks" of stores. There are many new and modernistic signs, sparkling display rooms, viewing "theaters," and improved storefronts and interiors. Dealers have a heavy investment in TV with all of the improvements they've made, plus the equipment to maintain and install receivers.

NEW, INCREASED OR BROADENED GENERAL SALES TAXES will be widely proposed by 1951 state legislatures. A new general sales tax will be strongly advocated in Georgia next year, with many regarding its enactment as a virtual certainty. Adoption of a new sales tax looms as highly probable in South Carolina. Other states in which new sales taxes are likely to be proposed include Maine, Massachusetts, Minnesota, New Hampshire and Pennsylvania. States in which increased or broadened general sales taxes may be proposed include Connecticut, Florida, Illinois, Maryland and Washington.

CLOTHES DRYER VOLUME CLIMES. Steady increase noted in sales of this comparatively new product. For instance, total sales last July were up 750 per cent over July of the previous year. Those dealers who are moving quantities of dryers find this product a good add-on item to the otherwise complete home laundry, and, in addition, there's no trade-in problem.



SERVICE DEPARTMENTS HAVE NEVER BEEN SO busy as they are now. Most shops are far behind with TV installation and repair work, and the situation is worsened by the difficulty in obtaining certain tubes and parts. Some dealers haven't enough help; have lost men to the military, and others report some of their servicers have taken jobs in factories.

LIKE TV USERS, THOSE OWNING RECORDERS do a lot of selling work for the product. New uses are found for recorders every day, and from here on watch sales climb steadily. Sales for 1950 may reach 400,000 units in all types now on the market.

ANSWERING YOUR QUESTIONS ABOUT COLOR TV

see following 2 pages.

For technical questions and answers, see Service & Sound section, this issue.

Answering Your Questions

Facts About the Color-TV Situation the

- *Should I Buy This TV Set Now, or is it likely to become obsolete in a year or two?*

You may buy right now, with the assurance that your investment insures you years of enjoyment, to the full extent of the natural life of the set.

- *But I Hear That There Is Color TV; Will This Set Receive It?*

The black and white TV now being broadcast is the commercial standard . . . is bringing you top entertainment on hundreds of shows *right now* and will continue to do so for years to come. Color TV, of which you may have heard, is still experimental. There are no commercial programs available, no sets for sale. There will be eventually, but not for some time to come.

- *But If and When They Do Have Color Programs, What Will Happen to My Set?*

When you decide that you want to see the few, odd-time color programs which will be broadcast as well as the regular black and white ones, your set can be

adapted to receive these programs. Your set will never be obsolete, any more than coal furnaces were made obsolescent by the invention of the oil burner.

- *But Wouldn't It Be Better for Me to Wait for a Set With a Built-in Adapter?*

No. We do not know exactly how long it may be before such sets are available, since standards for them have not been finally set, nor do we know how much more than present sets they will cost. By waiting, you will be penalizing yourself in that you will be missing from six months to a year's worth of enjoyment . . . and you will have gained little, for black and white TV will still be the standard.

- *Will a Set With Adapter Receive Both Black-and-White and Color?*

A set with adapter will receive present black-and-white programs, plus a *black and white version of the color* programs. It will not show colored pictures. Only an adapted set with a "converter" including a revolving color disc in front of the picture, will show it in color, and only a picture of

What Industry Leaders Say about the Color TV Situation

RADIO-TV MFRS' ASSN. Robert C. Sprague, president: "All the many fine black-and-white TV programs now on the air . . . will continue to be enjoyed by an increasing audience of over 25,000,000 million people who will see these programs on the eight million black-and-white sets which have already been purchased. The vast majority of engineers and scientists believe that there will be available within a reasonable length of time a satisfactory color system which is compatible with present black-and-white, which can be received without any change on or addition to these sets whatsoever or added cost to their owners."

PHILCO. William Balderston, president: "Black and white is and will continue to be the basic system of commercial television for years to come."

RCA VICTOR. W. A. Buck, vice-president: "The present outstanding program service in black and white television will be continued, expanded and improved for years to come."

ADMIRAL. Ross D. Siragusa, president: "It is my opinion that of the 10 million sets which will be in service by the end of the year, not 5% will ever be made compatible with the Columbia system."

GENERAL ELECTRIC. A. A. Brandt, general sales manager: "There is nothing in the FCC color decision that indicates, even remotely, that present black-and-white television broadcasting over these (107 stations in 48 major cities) will be discontinued at any time in the future."

DU MONT. Dr. Allen B. Du Mont, president: "We have been observing the reception of the CBS color system as compared with the present 525 line black-and-white standards. When these are compared side by side we do not believe that people would be interested in purchasing color receivers."

MOTOROLA. Robert W. Galvin, vice-president: "The CBS color system is so impractical that it will die down as soon as the public gets all the facts. Television owners can be assured their present sets will serve them indefinitely."

MECK. John S. Meck, president: "Next spring the most popular tube size will be 21 inches. The whirling disc needed to produce color pictures from this tube would have to be about 54 inches wide . . . would have to revolve at 50 miles an hour at its circumference."

About Color Television

Dealer Can Pass on to Inquiring Customers

12½-inch size or less will accommodate this disc. Today everybody wants 16-in. and 19-in. sets. And 21-in. and 24-in. will be favorites in '51.

● *Will My Guarantee or Service Contract Cover Adaptation if I Buy Now?*

No. If you wish, at any time in the future, to have adaptation made, it will be at your own expense, but considerably less than the cost of a new set with built-in adaptation.

● *Is 12½-inch the Largest Picture That Could Be Had in Color?*

Yes. Color discs for Pix tubes larger than that would be a physical impracticality. No other method for getting a larger picture on the CBS-type field sequential color TV system has yet been found to be successful.

● *Are Color Programs Available, Now?*

No. Color broadcasts are scheduled to start in New York City, and possibly one or two other cities, after November 20. These will be largely experimental,

probably unsponsored programs, mostly in hours not now devoted to TV broadcasting (early morning, late at night). If you do not live in New York, color broadcasts of any nature will be available only at rare intervals, if at all.

● *Will Milton Berle, Ed Sullivan, Stop the Music, etc., Be on Color Now?*

No. . . . and it is unlikely that such programs and their counterparts, which make up the cream of TV entertainment, will be available on color broadcasts for a long time to come.

● *So, if I Buy Now, My Set Will Not Become Obsolete? Right !*

There Are no Good Color Programs Available Now? Right !

If There Is Ever Color, My Set Can Be Adapted? Right !

But if I Want to See Pictures in Color I will be Limited to a Twelve-inch Picture?

Right !

Quoting Statements to Reassure the Dealer and His Customers

HALLICRAFTERS. Wm. J. Halligan, president: "The tremendous interest in present black-and-white programming far outstrips the miniscule, experimental type of program presentation that CBS color will be able to offer."

HOFFMAN. H. L. Hoffman, president: "The present black-and-white system will continue to be used, which means that every owner of a present set will get all of the entertainment he contemplated when he bought. This holds for the prospective buyer as well."

FREED-EISEMANN. Joshua Sieger, vice-president: "It is certainly no wonder that not one single television manufacturer is willing to invest a single cent in the manufacture of color receivers based on this antiquated system."

FADA. J. M. Marks, president: "When color TV does come it will be a compatible system which will not obsolete the 9,000,000 sets now in use."

OLYMPIC. Percy L. Schoenen, vice-president: "Public will continue to demand standard black-and-white programs in ever-increasing quantities in order to enjoy the entertainment thus available to them."

PILOT. Isidor Goldberg, president: "You can buy any reputable make of TV set today with confidence."

CROSLEY. John W. Craig, vice-president: "Seems unlikely that the public will pay higher prices for a degraded color TV system."

ZENITH. Comm. E. F. McDonald, Jr., president: "We have no intention of slowing or halting the manufacture of black-and-white sets."

MAJESTIC. Leonard Ashbach, president: "Television dealers and the public may be sure that current black-and-white TV receivers will fulfill a long period of usefulness and will not be in danger of becoming obsolete."

TELE KING. Louis I. Pokrass, chairman board: "It will be years before color will be ready for general use."

CBS. Frank Stanton, president: "Present television sets will remain useful to their owners for the normal life of the sets. Present black-and-white sets will continue to receive present black-and-white programs. These programs will continue for a considerable period of time."

YOU SELL quality across

Get set to demand



45EY15

It's the children's edition of the famous "Victrola" 45 phonograph. Brightly decorated with funny Disney characters, it's the ideal children's Christmas gift promotion. Non-breakable 7-inch "45" records are perfect for kiddies.

BX6

Newest version of the favorite "Globe Trotter." Plays on battery or AC-DC current. Has built-in antenna, automatic volume control, "on-off" lid switch. Aluminum finish with brown plastic ends, simulated leather trim. Less batteries.



9X561

Superb sound with large 8-inch speaker. Has "Golden Throat" tone, built-in Magic Loop antenna with outside connection, phono plug-in. In dark maroon or antique ivory finished plastic.



9X571

Features 8-inch speaker, largest in any RCA Victor table radio. Has "Golden Throat" tone system, plug-in phono jack. Plastic cabinet; striped mahogany on maroon or blond on beige.

the board With RCA VICTOR

meet heavy pre-Christmas
with these sure sellers

Teamwork, all the way through, lies behind consumers' preference for RCA Victor quality. From the first precision part that's inserted on the production line . . . to that last ounce of hard-hitting RCA Victor advertising and promotion . . . you can be sure your RCA Victor line has what it takes to keep on being your top quality, top selling brand.

Heavy magazine, newspaper, radio and television advertising is driving home the RCA Victor sales message . . . and driving more and more Christmas shoppers your way. Make use of RCA Victor's countless "Demo" selling features to show customers what they *want* to see. You'll clinch many more profitable sales, sure!

There's a top-quality RCA Victor instrument for your every pre-Christmas prospect—whether he wants the best in radio, recorded music or television. Now's the time to start "pushing" RCA Victor. More sales of these high-quality items mean more satisfied customers who will keep coming back to build a year-in, year-out volume of handsome profits.



Combination Roll-Out Unit

When the set is a combination, shows customers how the radio and the "45" record changer are combined in a single compact unit. They'll watch you roll it in and out . . . and see how the unit saves space, increases enjoyment.



Distortion-Free Music

When the set has a "Victrola" 45 record changer, let customers listen to the distortion-free reproduction. Explain how the handy 7-inch discs are distortion-free over their entire playing surface.



"Golden Throat" Tone System

Tell them about the unbelievable tone brilliance the exclusive RCA Victor system produces . . . how it makes sound life-like by balancing all high-quality parts exactly. *Let them listen.*



Beautiful Cabinetry

Have shoppers run their hands over the fine finish. Point out the choice matched grain patterns and sturdy harmonizing trim. They'll go for the selection of finishes you offer them.



45W9
Powerful AM-FM radio and "45" recorded music in the roll-out unit. Has storage space for four hundred "45" records, or 60 albums. The 45W9 features richer, more lifelike Extended Tone Range.



6T71
It's the "Fairfield," 16-inch Million Proof television with phono jack to plug in "45" or other record changers. Has rich, fine "Golden Throat" tone system. Good-looking cabinet adds real eye-appeal for "Demo" selling.

DON'T FORGET...

To tell shoppers about the Extended Tone Range in many "Victrola" combinations . . . how it adds to the beauty of the "Golden Throat." And when the set has television, show them

the clear, steady pictures. Drop a gentle reminder that RCA Victor television brings Million Proof satisfaction . . . satisfaction proven in over a million homes.

ONLY RCA VICTOR

HAS THE "GOLDEN THROAT"

"Victrola"—T.M. Reg. U. S. Pat. Off.

RCA VICTOR



DIVISION OF RADIO CORPORATION OF AMERICA

ONLY RCA VICTOR MAKES THE "VICTROLA"

RCA VICTOR—World Leader in Radio . . . First in Recorded Music . . . First in Television

What's Ahead!—in Radio,

THOUGH PRICE-CUTTING PACE has slowed down, a considerable number of outlets are still slashing list prices, even on high-demand items. Discount houses and other similar operators have, however, shortened the amount of the "offage" on the more popular brands. Since many of such organizations are short-stocked they are taking orders for what they promise to be "early delivery," and are demanding small payments from customers.

COOPERATIVES ARE NOT EXEMPT FROM THE TERMS OF STATE FAIR TRADE LAWS, permitting manufacturers to establish minimum resale prices for their branded products, according to an opinion handed down in Philadelphia by Federal District Court Judge Kirkpatrick. The judge ruled that the Civil Service Employees Cooperative Association violated fair trade laws by selling certain electrical appliances for less than minimum resale prices fixed by fair trade contracts. It was said to be the first ruling on the question of whether such an organization is subject to fair trade laws.

IN ADDITION TO STATE SALES TAXES, there has been an increase in recent years in the number of cities imposing local sales taxes, especially in California where more than 120 cities levy local sales taxes up to 1 per cent.

WHEN YOU HAVEN'T SEEN OR HEARD from a one-time steady customer for some time, give him a ring or pay him a visit. Maybe such customer is sore about something, or maybe he's switched to another merchant. A friendly call often brings such absentee back to the fold.

PHONO RECORD SALES-UPPERS. Know what you have in stock, and where it is. When out of a requested platter, have a substitute suggestion on the tip of your tongue. Never say, "I don't think we have it", when you're in doubt; find out first, then give your answer. Don't say, "Anything else?"—offer some suggestions. Process delivery of out-of-stock items with utmost possible speed.

"YOU HAVE PROBABLY BEEN WATCHING the trend toward larger picture screens and wondering how big and how dominating in the average living room cabinets would have to become. Picture sizes are going to continue to get bigger, but cabinet sizes will not need to be increased appreciably. Within five years I expect 27 to 30 inch rectangular tubes will be the standard. The 30-inch tube will give a picture area approximately 19 by 25 inches or twice the area of the present round 19 inch tube. Scientific development of the 30-inch rectangular tube will make this possible with cabinets not much larger than the ones now needed for the 19 inch circular tube."—Ross D. Siragusa, president, Admiral Corp.

TELEVISION SETS IN USE as of November 1 have reached 8,900,000. There are 107 TV stations on the air and there will not be any new ones this year. There is little likelihood that the freeze will end during 1950 and so no new TV station allocations can be made until some time during 1951. 47 of the 63 market areas with TV are now connected by cable or microwave relay so that they are able to receive network programs. This includes 80 of the 107 stations. In addition, Los Angeles and San Francisco are connected to each other.

THE SIGHT OF A WASHING MACHINE SALESMAN rubbing a clean towel on a dirty sidewalk attracted a lot of attention and made a lot of sales for one dealer. Such unusual gimmick was for the purpose of getting people to come into the store where a demonstration center was set up just inside the show-window. Any store visitor who expressed interest was handed the salesman's watch with the request to "hold it for three minutes." In this manner, the prospect had to watch the demonstration—see the once-dirty towel come out of the washer clean as a whistle.

WITH COSTS OF HOME DEMONSTRATIONS figured to be three times more than those prevailing in immediate pre-war days, wise merchants are screening all home trial requests. One retailer who is very successful, has laid down the following three rules: 1. Sends TV and appliances out to customers he knows well, with no questions asked. 2. With all others, he asks for and gets credit information and a signed, conditional order. 3. He follows up all in-home trials promptly; following day on TV, minimum of 3 days on laundry equipment, one day on vacuum cleaners.



LOOK FOR BIG CHRISTMAS BUSINESS in phono records and players. Dealers are urged to get holiday windows in on platters early this year—right after Thanksgiving.

A NEW AND DIFFERENT METHOD for pointing out a person or item in a television picture has been announced by the General Electric Company. The new device enables narrator to insert a black and white pointer about 30 lines high and seven lines wide at any point in the TV picture, to more effectively describe the action taking place. Called the Electronic Pointer, type TV-34-A, this unique new programming tool consists of a rack mounted chassis and a simple control unit, which may be located anywhere a picture is available to the operator.

Appliances, Records and Television

RADIO RECEIVERS CONTINUE TO BE in short supply in many parts of the country, with the demand very brisk. In anticipation of a big Christmas season, dealers are combing the market in efforts to build up sufficiently large inventories.

IT WILL COST BUSINESSMEN MORE TO DO business under the amended Social Security Law, which becomes effective January 1, 1951, points out the Electric Institute of Washington in a bulletin to dealers, which explains the Act as follows: The wage base subject to tax will go up from \$3,000 annually to \$3,600. Tax rate stays at 1½ percent until 1954 but will be gradually increased until it reaches 3¾ percent in 1970. A lot more workers, including salesmen selling to retailers and wholesalers, will be covered. Self-employed people will also come under the Act. House-to-house salesmen on commission basis are likewise included. First payment of self-employed people must be made for year 1951, due March 15, 1952. Rate for self-employed is 2¼ percent until 1954 and will reach a maximum of 4¾ percent by 1970.

HOW TO HANDLE THE 10% TV EXCISE TAX, going into effect this month, puzzling manufacturers who've been in numerous and frequent huddles. As we went to press, no manufacturer has announced how he proposes to take care of the new tax. At the retail level, many dealers used the imminent tax as a "buy-now" angle.

REGULATION W, RECENTLY REVIVED, TIGHTENED UP, now requires 25 per cent down payment on TV, radios, electrical appliances, and cuts time to pay from 18 months to 15 months. The revived regulation went into effect Sept. 18; was changed Oct. 16. Widespread protests have been voiced by manufacturers, wholesalers and dealers.

IT PAYS TO PAY ATTENTION to what the customer has to say about what's wrong with his radio, TV set, or appliance. Often the diagnosis is correct. Frequently, the customer's description of the trouble is a genuine clue. The dealer who listens to the service complaint with an open mind can frequently save money and time. After all, the customer lives with the product, and, therefore, with but a smattering of mechanical or electrical knowledge, can often put his finger on the cause. Moral: Don't scoff at customer-supplied clues. Your cynicism may cost you dough.

PROTECT THE TOPS OF THOSE TV AND RADIO SETS with padded covers. This procedure will guard against damage by store visitors who frequently place packages, umbrellas, handbags and other objects on the polished surface. Keep your display receivers in saleable condition.

LOOK FOR STATE LEGISLATIVE PROPOSALS directly and indirectly affecting merchandising to be pressed on a broad scale next year when the lawmaking bodies of 44 states convene in regular sessions. Bills proposing new and stronger unfair trade practices acts of general application, outlawing the sale of merchandise at less than cost, will be introduced in many states in 1951. Originating in California in 1935, such laws are now on the statute books of some 29 states. In past years a law of this type was invalidated by the courts of New Jersey but similar measures were upheld in a number of other states, including Arizona, California, Colorado, Kentucky, Minnesota, Montana, Tennessee and Wyoming.

VERSATILE SOUND WAVES well beyond the range of human hearing are being harnessed for a score of unusual jobs in the future, according to Westinghouse engineers. They include clothes washing, smoke clearance, germ killing, television transmission, flaw testing and even mixing oil and water.

REPORTED WITHOUT COMMENT. A young fellow came into a store where one of our editors was making a call. He asked the suburban New York merchant what was "the best price" on a certain popular TV set model, and having received a quotation, the list price, said, "What's wrong with all the dealers in this town, anyway? They sure make it hard to buy. Don't they want any business? I've shopped all over town and nobody's willing to give me anything off." Incidentally, there's a

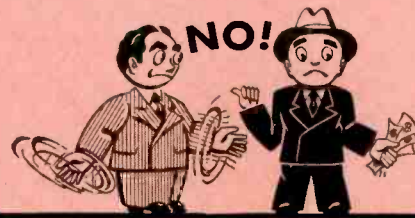

very strong dealer organization in the locality where this incident took place, which probably had a great deal to do with the difficulty the customer was having in trying to make a purchase along lines he doubtless accepted as common practice.

Future Events of Interest to Readers

Nov. 13-16: NEMA Annual Meeting, Chalfonte-Haddon Hall, Atlantic City, N. J.

Nov. 17-19: West Coast Refrigeration and Air Conditioning, Municipal Auditorium, Long Beach, Calif.

Feb. 5-8: AAMA Exposition, Grand Central Palace, New York.

Feb. 5-9: Western Winter Market, Merchandise Mart, San Francisco.

May 21-23: 1951 Parts Distributors Conference and Show, Stevens Hotel, Chicago.

Selling This Christmas

Dealers Urged to Use Good-Will Methods, With No Let-Down in Effort.

Caution Is the Buying Buyword in Situation Laden With Uncertainties

• The Christmas selling season is almost at hand, and while business promises to break all records it will be a difficult market for any dealer to operate in. As it appears now, the chief problems will be to get enough of certain products in this market, and to handle transactions under the new credit control law; explain color TV to the "waiters," and overcome objections at present prices.

In addition to the problem associated with getting enough products, many dealers are being faced with a shortage of good sales and service help. Service departments in many parts of the country are being, and will be further swamped with work, and some are experiencing consider-

able difficulty in getting certain parts, tubes, etc. In TV areas, there's going to be a crying demand for last-minute set installations which will sorely tax the facilities of shops of all sizes.

While it doesn't seem at all likely that dealers will experience any difficulty in selling a tremendous volume of business between now and Christmas, such selling will be hard to handle from the viewpoint of keeping customers happy. Some wanted products will not be available, causing disappointment to numbers of people. High prices, combined with the overall rising costs of living, will contribute to the merchandising problem, though this factor will be cush-

ioned to a great extent by the high employment rate, and by the fact that consumers in general have money on hand.

In some sections of the country, dealers have lost personnel to defense plants and to the armed forces, and, therefore have to find and train new people to sell and to maintain the products sold by the store. Since, as stated previously, sales will be easy to obtain, the main job facing the dealer is one calling for ingenuity, courtesy and tact in maintaining customer good-will, and trying to make this a Christmas-as-usual for the people in the community.

While it's true that there isn't much peace on earth nowadays, the dealer can sell via the good-will route, and with the proper Christmas spirit. In this way, he can help build up the public morale in his community. Those stores whose owners permit salespeople to use war alibis to cover shortages of wanted products, and who use madhouse tactics in offering substitutes, and who gloss over complaints about high prices or slow service will create a tense atmosphere that those customers who do come back will not forget in a hurry.

In spite of the difficulties he seems bound to face this Christmas, the smart dealer knows that the one thing he can do, and do without costing him a dime more, is to insist that the proper Christmas spirit prevail in his store. He knows that courtesy is a sales tool that's free to use; that it's just as easy to be pleasant and friendly to customers who may be disturbed over not being able to get what they want as it is to be abrupt or discourteous to them.

Briefing Personnel

One important pre-Christmas selling step to take is the thorough briefing of the entire personnel, from the top to the bottom. The salespeople must know how to handle the disappointed customer's problems. They must be urged to *sell* substitute products *on the merit of the product*, and not upon any take-it-or-leave-it angle. They must be prepared to justify price increases as a burden shared alike by dealer and customer, since the merchant's rate of discount remains the same, while his expenses are away up. They should not make promises of delivery of products they

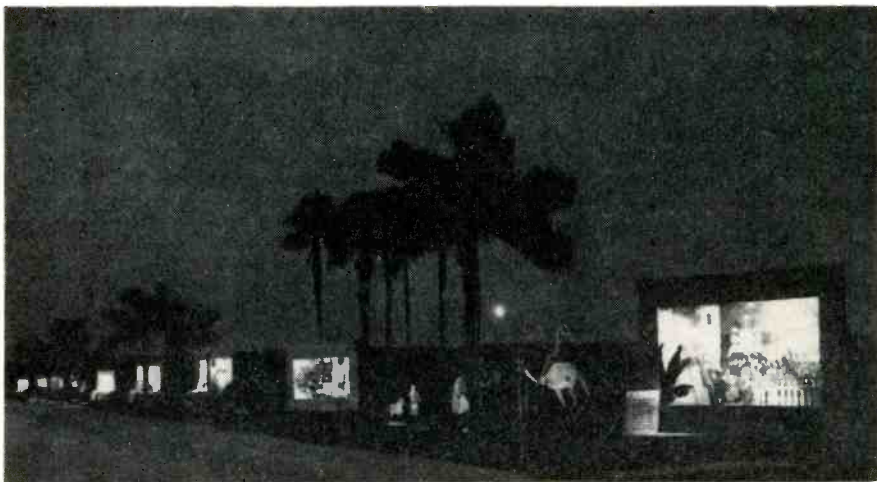

Scene above is Christmas display at Christmas Card Lane, Bayshore Drive, Tampa, Florida.

PLAN NOW TO

Brief all employes on necessity for trying to make this a Christmas-as-usual for your customers

Handle substitution selling courteously, skilfully and intelligently. Sell such products on their own merit

Don't use scare-buying themes in your Xmas advertising. Feature what you have on hand. Extend personal greetings in copy

Buy carefully; watch especially those highly-seasonal gift items which you don't want to carry over another year

Give your store that Christmas atmosphere. Devote proper attention to displays in store and in show-windows



Sell with the proper Christmas spirit to guard your good-will. Above, Yuletide display on green at Taunton, Mass.

know are impossible to get in time for Christmas. Such tactics will result in making enemies of customers, and will cause an accumulation of "neglected" products in the store.

Christmas Servicing

The dealer who wants to operate his store in the proper Christmas spirit will make certain that his servicers meet the difficult job at hand with courteous, considerate treatment of all customers. Because of the rush of Christmas selling, and the generally high demand for products this season, the dealer's servicemen will be in the homes of the customers more frequently than will be his salesmen. Servicers are going to be given some hard times, and whether they react favorably or unfavorably in their relationships with customers depends upon how rigidly they are briefed by their employers. Numbers of dealers will be hiring new men who will need special training before they are permitted to enter the home of the customer who is the merchant's *sole source of income*.

Keep Christmas Atmosphere

Special briefing should be given clerical employees who are called on to take service calls and complaints, or who are accustomed to meet and talk with customers regarding bills, etc. They should be urged to exercise special care in guarding the store's good-will structure this Christmas.

At the management level there

should be no let-down in such activities as window-dressing in-store displays and advertising. Some dealers, faced with the prospects of a store-wide sellout this holiday season may feel that it isn't necessary to do more than a token amount of decorating, but those who want to make this Yuletide as much of a Christmas-as-usual as is possible will do a forthright job of setting up appropriate window displays, and will go all-out in making the inside of the store sing Christmas. The alert merchandiser will also provide adequate facilities for gift-wrapping, packing and unpacking; will plan, and publicize via signs, to keep open later in the evening, and is thinking now about extra salespeople he may need, and where to get them.

The Supply Situation

While the dealer should continue to try to obtain such merchandise as he has back-ordered, he should not, as pointed out in previous articles dealing with the present situation, run himself ragged in such effort. Also, he needs to exercise great care and judgment in buying to eliminate the possibility of overstocking certain items. This is particularly true of gift items which he customarily sells only at Christmas time.

Even so far as the fast-selling, high-demand are concerned, he needs to buy with caution, realizing that if all the back-orders by dealers in this field today were to be filled tomorrow the market would be seriously glutted. Caution is needed in buying even for

what promises to be a record-breaking Christmas season, the merchant knows, because he must think of the immediate post-Christmas period, and try to figure out how he will stand, inventory-wise at that time.

Another factor to consider in buying, or in making commitments to buy is the possibility that a considerable amount of merchandise is being held by speculators who hope to take advantage of additional price rises, or who perhaps plan black market operations in case scarcities persist. While no concrete evidence of such hoarding is available, if it does exist, and price roll-backs were to be imposed, the impact of suddenly released inventories could seriously affect the dealer's business. In light of all the present conditions, the merchant should be mostly concerned with selling what he has, and not worrying too much over the products not readily available to him.

Christmas Advertising

The dealer who wants to spread Christmas cheer among his customers will not use scare-buying themes in his Christmas advertising, although, as usual, he will urge early buying, and he will stress in his copy, the products which he has in good supply. This will help move such merchandise, and will help shoppers solve gift problems. The use of lettered "shopping lists" in show-windows will bring in a lot of business from the street.

(Continued on page 92)

This Merchant Sells

New Orleans Dealer Gears Store to Present Conditions.



(Above) Dealer Magoni is a strong believer in providing salesfloor entertainment. Here, the TV sets have captured the interest of a little girl whose mother joined her a few moments after this picture was taken. (Below) Customers often make up their minds to buy certain models before talking with a salesman.



• In many TV, radio and appliance stores, a seller's market—or at any rate, a partial seller's market—is being experienced at this time.

Furthermore, it may be the established order of things for some years to come, if vastly increased spending for defense equipment is an indication (and many economists say it is) of less and less steel and other raw materials for the dealer to sell in the form of TV sets, radios, and appliances. In a seller's market, what can you do to keep customer friendships? What is there to sell? Why sell anyway?

No Relaxation

"We sell—and we're going to keep on doing so, to establish ourselves, not only now, but for the long range future," says R. J. Magoni. Mr. Magoni, one of New Orleans' most respected appliance merchants, and an authority whose opinions are frequently sought in the merchandising field, believes in *selling* in a *seller's* market.

"But it is a different kind of selling," he says. "We could cut out advertising, and with the increased demand today still sell all the TV sets we could lay our hands on simply by putting them in a spot where they could be seen from the street. But we are not cutting out advertising, not by a long shot. We look at the seller's market this way: Demand or no, scarcity or lack, or abundance, *we*

have something just as important as any appliance to sell. That is ourselves. The store. The idea that we are a square-dealing, good place at which to buy any product at any time.

"We could cut out all selling effort, but we are not going to do so. Why sell? Well, if a dealer's ads are designed to sell the store institutionally, then picture what would happen if a customer entered the door after reading one of such ads and found, for instance, a lackadaisical salesman with his feet on the desk, assuming a 'look around for yourself' attitude. Does what the customer read in the paper jibe with what is to be seen on our floor? Of course not. Such methods not only drive customers away, but waste good money spent on advertising. However, we are changing our selling techniques, gearing them to fit the present situation of a mobilization economy."

Training Salesmen

Mr. Magoni is the radio and appliance sales manager of Barnett's 600 Carondelet St., New Orleans. Until the Korean Reds crossed the 38th Parallel to plunge the world into warlike moves once more, he had one of the hardest-selling set-ups in the U.S. Barnett's salesmen spent five days out of every week "on the street," cold canvassing or else following up leads that resulted from the barrage of full and half-page advertisements which Robert Magoni kept in the three New Orleans daily papers. To get a floor day, the salesman had to "earn" it by turning in a certain out-of-the-store sales quota. The store was very active in add-on selling. "We tried to sell every customer other products which would logically go with the ones they came to buy," Mr. Magoni explains.

Post-Sale Selling

Magoni employed an effective idea in post-sale selling. The cashiers' windows were located at the back of his big street level appliance floor. When a customer paid his time account past a certain point—usually two-thirds—the cashier pressed a button to signal to a floor salesman that here was a prime prospect. The salesman on duty met the customer on his way toward the door, got into conversation, reminded him that Barnett's would be glad to extend the existing account—and usually sold another appliance.

"All of that is out now," Magoni

via New Methods

Holds Customer Good-Will. Offers Comparable Models as Substitutes

says. "What is the use of arousing a wish to buy what we cannot furnish? We have pulled our outside sales crew back off the street. They now demonstrate and sell on the floor. Yes, we follow up all leads. But we do it only by telephone, and invite the customer to visit the store. We make after-sale calls on the telephone, too. "Our advertising occasionally men-

brand, we will offer the latter, employing good salesmanship in presenting it. This may be standard practice in some stores every day in the week, but we did not do it when we had all the sets we wanted. We got what that customer came to buy, if we had to get it delivered by the distributor. "When this semi-shortage first came, I tried to do what Barnett's had done

In Present Difficult Market —

Merchant Magoni concentrates on in-store selling

He continues to advertise in newspapers 3 times a week

To make up for shortages, he stresses sales of comparable models

He makes every effort to hold old customers and to attract new ones

tions merchandise; it is not entirely institutional. But if quantities are short we say so, not in a spirit of scare advertising, but in a desire to truthfully tell the whole story.

Holding Customers

"We aren't actually out of appliances, but our inventory sometimes gets woefully short. As a result, our salesmen have been instructed to try to switch preferences where they cannot furnish the brand that the customer wanted to buy. If a customer wants a certain make TV set, let's say, and we have no set in the style and size he wants to own, but we do have a comparable model of another

successfully just after the last war: We'd say, 'wait and we'll get it for you later.' I found it didn't work. Maybe the reason is that people are afraid that if they wait they won't get anything at all, or perhaps some high-pressure boys elsewhere got to work on them, but in nearly every case when we called a customer to report that the appliance he wanted had arrived, we discovered that Mister Customer had substituted another brand for what he originally wanted, and had purchased it elsewhere. So today we try to make up their minds while they are still on our selling floor, by suggesting comparable models from Barnett's stock. No high pressure stuff—just suggestion—but it works.



Nowadays, it's not at all unusual for a crated set to be sold as is, right off the salesfloor.

"We stay in the newspapers two or three times every week, with either institutional ads or merchandise ads that are low rather than high-pressure. We want people, thousands of people, to continue being aware that Barnett's is on Carondelet street, and that it is a mighty good place at which to buy."

(Below, left) Barnett's has brought its outside salesforce into the store. The small "set alley" shows off table models at eye-level. (Right) Barnett's keeps displays of radio and TV sets separate from appliances. This electric housewares counter is a real sales prop.

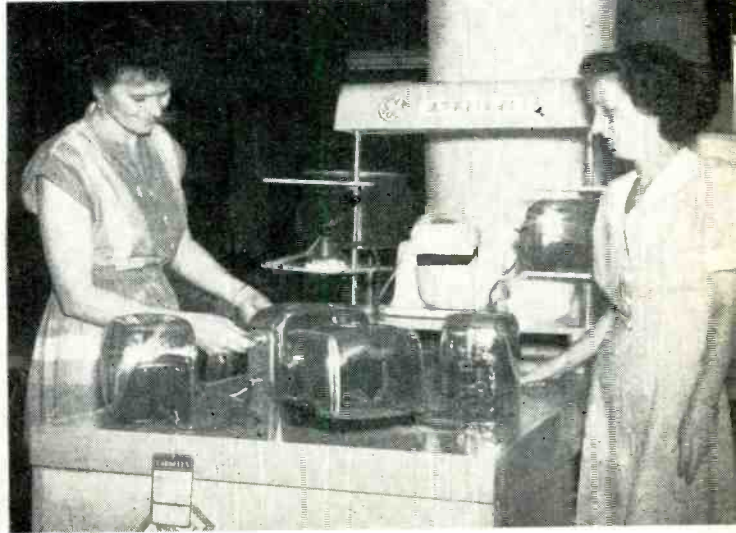



A scene from a commercial announcement on the "Morey Amsterdam Show," sponsored by the Allen B. DuMont Labs.



Scene from a recent "Lights Out" show sponsored weekly on ABC by Admiral, which also sponsors "Stop the Music."



Comedian Sid Caesar is seen weekly on the NBC "Show of Shows," part of which is sponsored by Crosley.

Use TV Shows to Sell Sets!



"Svengali" was produced recently on the Westinghouse program "Studio One," CBS television network.



Bud Collier MC's "Beat the Clock," audience participation show on CBS, sponsored by Sylvania Electric Products.



The Hallicrafters Co. has prepared spot film commercials for TV. Above: Milton Cross describes the Dynamic Tuner.



Hoffman Radio sponsors a number of programs in local markets. Scene above is from the "Hoffman Hayride."



"High Tor," a high spot on the weekly Philco TV Playhouse, NBC-TV network. Philco also sponsors the "Don McNeill TV Club" on ABC.



"Kukla, Fran & Ollie," on 54 NBC stations 5 nights weekly, are sponsored twice a week by RCA Victor.



Above, Larry Semon, announcer for "The Clock" program, sponsored by Emerson Radio, coast-to-coast in 40 cities.



"Uncle Lumpy" Brannum's Little Orley stories are heard on the Fred Waring TV Show, sponsored weekly by GE.

Pictured on these pages are some of the leading television shows sponsored by TV set manufacturers. These shows have a three-way advantage for alert radio-TV dealers. First, by presenting top-notch entertainment, they increase the amount of good programming available. This fact is essential to public acceptance of TV, and dealers are wise who call attention to programming when selling sets. Second, they create goodwill for the sponsor, and so indirectly pave the way for a good reception of his brand in your store. Third, they actively sell sets during the commercial interludes in these programs, naming models, showing the customer visually what the set looks like, and pointing out the salable features of the sets. This advertising helps pre-sell the customer for the dealer.



Ed Wynn is one of the comedy stars appearing on "Four Star Revue" sponsored by Motorola, Inc. weekly on the NBC-TV network.



North American Philips is sponsoring newscasts in local markets. Shown here: CBS newsmen Allen Jackson.



A scene from "The Tale of the Wolf" on the "Magnavox Theatre," sponsored by the Magnavox Co. on CBS on alternate weeks.

In Spite of Obstacles TV Marches On!

**Vigorous Demand Helps Industry Effectively Face Color TV,
Upped Credit Terms, Excise Tax Problems**

• It's a good thing that Television is such a lusty infant!

It's a good thing, too, that the market is healthy, and that consumers want, and will have television now. It's a good thing for all of us that TV will continue to march on, in spite of at least four selling obstacles recently placed in its path of progress.

Running neck-and-neck for dubious top honors in making it tougher to sell TV are the FCC's decision in favor of CBS color system and the tightening of Regulation W. (The latter affecting appliance sales as well as TV.)

Still another stumbling block to television (and to food freezer) sales is the excise tax, and the fourth, increased taxes.

So far as the color-TV decision is concerned, effects at the retail and wholesale levels have been spotty, mixed and hard to analyze. Immediately following the FCC decision, some dealers and jobbers reported cancellations. Reported, too, were floods of inquiries at all levels of the industry.

As this is written, the fever of color-TV interest on the part of the public appears to have died down considerably, with standard-set sales at normal or above normal in many retail outlets of all sizes.

accurate means for determining just how many people really want it. In the meantime, dealers are faced with the job of assuring customers that it's good business for them to buy sets now without fear of rapid obsolescence. (See "questions and answers" on color-TV on pages 38, 39 and 80, this issue.)

Stiff Credit Terms

When Regulation W went into effect last Sept. 18, the industry, for the most part accepted it graciously, and with little griping, feeling that its terms wouldn't seriously affect

What to Say When Your Customer Asks About Color- TV, See pages 38, 39 and 80, This Issue.

time-buying since they were fairly liberal. But, when the Regulation was tightened up one month after—certainly not long enough to give it a fair trial—manufacturers, wholesalers and dealers were up in arms, feeling that such drastically new terms were not necessary in the interests of holding down inflation, but would work hardships on low-income groups, and would reduce sales volume at manufacturing, wholesaling and retailing

credit is widely practiced, things may change since it is rumored that the Federal Reserve Board is now considering the limiting of time allowed to pay charge accounts as it did during World War 2.

Chin-Up Selling

All merchants can do at this stage of the game is to try to operate profitably in spite of the new credit terms which they will have to process to the letter. They can make drives for more cash sales, and can go after more charge account business, exercising great care in handling the latter because it seems quite likely that many more persons will be seeking open credit now that the time-payment plans have been so drastically stiffened.

We have had an inquiry asking whether a "lay-away" plan, in which a dealer would accept small payments at intervals, holding such money until the amount required for the down payment was paid, after which the sales contract would be executed, would violate any of the provisions of Regulation W. In such case, the dealer would not deliver the merchandise nor execute the contract until the full down payment had been accumulated. We have written to the Federal Reserve Board asking their opinion, and when this is received, we will print the information for the benefit of our readers.

Excise Tax Puzzle

As this is written, there is no authentic information as to how the excise tax problem will be handled by the industry. Needless to say, however, that it will make TV receivers cost more, which isn't helpful to business now, and might be a great deal worse after Christmas. Consumers have been buying heavily in anticipation of the tax, and dealer inventories are large at this time so far as the general picture is concerned, though many fast-moving products are still very scarce.

The entire market right now is one of confusion. As previously stated, dealers will feel the effects of increased taxes, particularly so far as those having limited incomes are concerned, and when the other factors are added, all go to point up the necessity for calm, careful planning

(Continued on page 104)

The New, New Regulation W

Now requires 25 per cent down payment on TV, radios, phonographs, electrical appliances. (When it became law, Sept. 18, 1950, it called for 15% down.)

Now requires that no longer than 15 months can be given to pay balance. (Terms on Sept. 18, 1950 were 15 months.)

Exemption reduced on all covered items from \$100 to \$50.

Many expert merchandisers feel that the public, after it has had time to fully digest all of the obviously complicated ramifications (and they've been printed in all the newspapers) associated with mechanical color, will forget all about it and that they will continue to buy black-and-white sets to get the fine programs now available to such sets. Incidentally, the consumer has never been consulted on color-TV, and there is no

levels where a high sales rate is necessary to meet increased costs and taxes in order to maintain a healthy economy.

Most dealers in most communities will be adversely affected by the terms of the recently tightened Regulation. A few dealers in the more wealthy communities, where time-selling is not much of a factor, will get along all right in spite of the new curbs. But even in such localities, where open

Sure There Are Other Boosters on the Market!

BUT... Your fringe area customers will more

**than THANK
YOU
for
selling**

ANCHOR

THE
FINEST TWO-STAGE
TV
Pre-Amplifier
EVER MANUFACTURED

List Price

\$44.95



Only ANCHOR can provide your customers with ALL of the most Ultra-Modern advantages for consistent, top-notch, long-range TV reception. Here's why!

- ANCHOR has the highest gain of any TWO-STAGE BOOSTER.
- ANCHOR has the highest Signal to Noise Ratio.
- ANCHOR is the only non-regenerative unit available. The unit that is not returned.
- ANCHOR'S Single Knob Construction is so convenient, for Booster is turned on and can be switched and tuned all on the same knob.
- ANCHOR'S New and Revolutionary method of construction of the RF Stage (Pat. Pend.) is the only real engineering advance in Boosters in recent years.
- ANCHOR'S TWO-STAGE BOOSTER is modernly styled with streamlined plastic escutcheon, soft mahogany leatherette finish.
- IMPORTANT! ANCHOR'S TWO-STAGE BOOSTER is often the answer to installation difficulties well within the normal TV areas where the New Single Stage Model fails to give complete satisfaction.



ANCHOR'S TWO-STAGE BOOSTERS NOW ROLLING OFF PRODUCTION LINE

Yes, the finest TWO-STAGE Pre-Amplifier is no longer a promise but a reality.. and what a reality! When you receive your first order be sure to study the instruction book which accompanies each ANCHOR TWO-STAGE Model ARC-101-100. You Retail Dealers will soon enjoy a tremendous promotional campaign backing all ANCHOR BOOSTERS so be sure YOU know all the answers. We'll send you the customers.

ANCHOR TIPS



ANCHOR employs a totally new method of construction of the RF Stages in maximum gain with best possible Signal to Noise Ratio. When the noise factor was measured in DB it actually showed up better than the best TV tuner tested at the Hazeltine Laboratories.

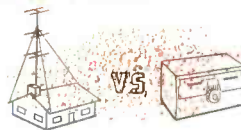

Your customers will thank you if you don't make an antenna installation that is too hazardous and costly when you can give them a more satisfactory installation at a profit to yourself with an ANCHOR BOOSTER.

OVER
100 MILES
CONSISTENT
TV RECEPTION



Field tests made by independent service engineers have proven the Anchor Booster can give consistent top-notch TV reception over 100 miles. This is not a possibility but a FACT! This, of course, will extend TV sales to many untapped markets.

ANCHOR
RADIO
CORP.

2215 SOUTH ST. LOUIS AVENUE

CHICAGO 23, ILLINOIS

ANCHOR ENGINEERING ALWAYS A YEAR AHEAD!

ANCHOR RADIO CORP.

2215 SOUTH ST. LOUIS AVENUE

CHICAGO 23, ILLINOIS

Capitalizes on Effective Sales

Well Organized Method of Disc Merchandising Pays Off for This Four-Way Merchant



Proprietor Sam Russo, son of retired founder James B. Russo, who started the business as a bicycle shop in 1905, at the Jay-Bee Record Bar. The master card file on all records in stock is build into the top of the record bar.

• Sam Russo, proprietor of James B. Russo and Son, radio-TV-appliance-record dealer of Brooklyn, N. Y., is particularly proud of his record department, which accounts for 30% of his annual dollar volume. This pride is not merely due to the fact that this department has a history extending back to the days of cylindrical records—when his father stocked the cylinders on the shelves in boxes, like boxes of shoes—; nor is it only due to the fact that he has one of the largest and most complete stocks of discs in a very populous trading area; or because he has customers come in from miles around to buy hard-to-get records (and even writing in from other parts of the country). His particular pride at this time is because of having come through a very trying period when other record dealers were experiencing severe cutbacks in disc sales—and in many cases closing record departments—while his business continued on more or less “as usual.” He could very well identify himself with the famous line of poetry, “if you can keep your head when all about you are losing theirs. . . .”

Mr. Russo feels that there are some very good reasons why his record sales held up, and justified a recent remodeling of the department. These

reasons may be boiled down to efficient methods and a well organized plan. This plan is based on taking a broad view, and a long-term view . . . and as a matter of fact, the plan has been in operation for a long time.

Mr. Russo is aware of the fact that you can't build a record business on hits alone, nor can you build up a clientele on street traffic. The customers of the “Jay-Bee” record shop come back again and again because they have learned that they are pretty sure to find what they want there (regardless of what it is), and they will get good service with a minimum of lost time and waste motion.

It is obvious that such service would be based on a good system for filing, storing and finding records, and that the sales people know their stock well and are experienced in selling it. The “Russo system” has the further advantage that even a new clerk or a part-time employe can find his or her way around it without too much difficulty.

There are many features to the system, but basically it starts with a card file, and this card file starts with the incoming shipment of records.

As soon as a box of records comes in, each new title is entered on a 3 by 5 card. This card will become a

permanent part of the filing system. Of course, in addition to the title, the card carries the name of the artist, the record manufacturer and the catalog number. When another recording of the same title comes in, it is entered on the same card by merely adding the name of the artist, record label and catalog number. Some cards in the Jay-Bee file have as many as 20 discs listed under the same song title.

The significance of the card is this: it reveals at a glance that the disc or discs listed thereon are *in stock*. In this respect it differs from any promotional lists provided by the manufacturer or jobber, which merely prove that the record exists.

A second advantage is that all records are filed under one system, in one place, and on one type of card. When a customer asks for a record, an inexperienced clerk need not know whether the record is new or old or whether it is Columbia, Victor, Decca, etc. He merely needs to know the title. If this title has *ever* been shipped into Russo's, there will be a card on it. This card will not only tell the number of the disc for which the customer asked, but also any other recordings of the same number *which have been received* by the store.

The record storage shelves are arranged by label, and by number within the area assigned to a label. With the number shown on the card, and a code letter affixed to it which indicates the “bin” or section in which that label is located, the clerk can quickly go to the right spot and get the record.

Customer Served Quickly

Mr. Russo considers it very important that a record customer be served quickly. He reasons that a record purchase is not a necessity, and that if the customer is kept waiting too long while the record salesman fumbles through two or three catalogs and a clip-board full of new release sheets, the customer will say, “Never mind,” and leave the store . . . or else he will remember this experience and go elsewhere next time.

In addition to this system, which is designed to simplify and streamline the filing and locating of records, a loose-leaf book on artists is maintained. The procedure for keeping this book is similar to that of the 3x5 cards, in that it starts with a new shipment of records. After the title is entered on the card, it is also entered under the artist's name in the

Plan for Phono Records

artist book. If there were no page for the artist (that is, if it is a new name), a page would be started the first time one of his records came into the store. After a while this page (or pages) would be a complete list of the records by this particular performer which have come into the store. If it should happen that the customer wants "That new record by Harry James," but doesn't know the title, the artist book will spot the record if it's in the store.

Special Orders Handled

Of course, it will inevitably happen that a record is out of stock, was never ordered in the first place, or is so new that it hasn't come in yet. It is part of the Russo service to offer to get any record for the customer, and quickly. It so happens that this store is located within a half-hour's ride to most of the record distributors' headquarters. Consequently, it is possible to fill two or three special orders within 24 hours, and this service is performed regularly as a matter of course in order to maintain the reputation of the store: that the customer can get anything he wants, whether they have it in stock or not. Of course, the store doesn't *rely* on these special pickups to maintain its reputation, but rather upon its stock of over 10,000 discs, plus its excellent system for being able to locate any of these records instantly.

So far we have only discussed the system. The layout of the record department is an integral part of its selling program. It is built in the form of a bar, complete with brass rail, stools and other accoutrements usually associated with a bar. The customer can sit down in comfort and listen to the record of his choice as if he were in a public place. Since the store also sells refrigerators, it was a relatively easy matter to keep one box running, and keep it stocked with bottled Coca-Cola. "Coke" is served to customers at the bar on request at no charge.

If the customer comes in without a particular record in mind, he is offered a "record menu" which lists: (A) The latest releases received in the store this week (not the latest release *form* from manufacturer or distributor but a typed list of records actually in the store); and (B) The current "top ten" hits. This gives the customer some concrete suggestions which invariably lead to a sale. These suggestions are, naturally, pop numbers. The store also handles classical albums and singles, but the greatest volume is in pop singles.

All the foregoing is predicated on



A small portion of the extensive stock of appliances carried at James B. Russo and Son, Brooklyn, N. Y. At left, Sam Russo shows a customer the interior of a Westinghouse refrigerator.

the customer who comes into the store. But how to get new customers to come into the store, and old ones to come in more often? Russo's have a continuous promotion program in operation at all times which is designed to achieve these aims.

First there are monthly mailings. The mailing list has been building for years, and is constantly culled, revised and added to. If, however, a customer moves to another neighborhood or even to another state, he is kept on

(Continued on page 90)

Closeup view of the card file which plays such an important part in the Russo system for merchandising records. Record salesclerk Francesca Cenzoprana is selecting a card. Record demonstrator is at her right.



New Radios, Phonos, TV Sets

This and following pages describing manufacturers' new merchandise are compiled by our editors. This information is presented as a news service to our readers entirely without any advertising consideration whatsoever.

RCA RADIO-PHONOS

Three new radio-phonograph consoles have been added to the line. They are the model 45W9, with AM and FM radio and 45 RPM phono, available in mahogany or walnut finish at \$189.95 and in limed oak finish at \$199.95; the model A-82, featuring AM radio, 45 RPM changer, and a separate changer for 78 and 33 1/3 RPM records, available in mahogany or walnut at \$209.95 and in limed oak at \$219.95; and the model A-91, shown here, a "five-in-one" entertainment unit, featuring AM and FM



radio and 3-speed record reproduction (two changers). The A-91 is available in mahogany or walnut at \$259.95, and in limed oak at \$269.95. RCA Victor Division, Radio Corp. of America, Camden, N. J.—RADIO & TELEVISION RETAILING.

Emerson PHONORADIO

A new Phonoradio model, No. 672, has been added to the line. Features AM radio and 3-speed phonograph. The



table model cabinet, with lid, is constructed of mahogany veneers. List price for the 672 is \$99.95. Emerson Radio & Phonograph Corp., 111 8th Ave., New York 11, N. Y.—RADIO & TELEVISION RETAILING.

Scott RAVENSWOOD

Available in either a table top or console model, this new TV receiver features a 16-inch rectangular picture tube. The table model, shown here, carries a

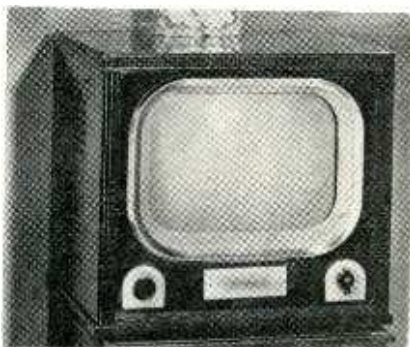

list price of \$249. The console model lists at \$279. Both cabinets are contemporary styled in dark mahogany. Scott Radio Laboratories, Inc., 4541 Ravenswood Ave., Chicago 40, Ill.—RADIO & TELEVISION RETAILING.

Westinghouse 20-INCH TV

Two new television receivers have been added to the line. One console, features a 20-inch picture tube. Called model 638K20, housed in a mahogany cabinet, it lists for \$439.95. The other model, the 636T17, is equipped with a 17-inch picture tube. It lists for \$249.95. Westinghouse Electric Corp., 1354 Susquehanna Ave., Sunbury, Pa.—RADIO & TELEVISION RETAILING.

Norelco JUMBO-VUE

Two new commercial TV sets, both controllable from distances up to 150 feet by a remote tuner, have been announced. The larger size, model 1200, with a picture 30" high and 40" wide, lists at \$895. The smaller model, 588, shown here, with a picture 21" high and 28" wide, lists at \$599.95. Both are



designed to provide satisfactory viewing up to 100 feet and more. North American Philips Co., Inc., 100 East 42nd St., New York 17, N. Y.—RADIO & TELEVISION RETAILING.

Majestic "MASTERCRAFT"

Five new TV consoles, called the "Mastercraft" series, have been announced. They include model 902, a 19-inch set in mahogany cabinet with full doors, listing at \$429.95; model 903, a bleached mahogany version, at \$459.95; model 7P1, a 17-inch TV-Phono combination in mahogany cabinet with two-thirds doors, at \$399.95; model 7P2, 17-inch TV-Phono combination shown here, in French Provincial cabinet with two-thirds doors in fruit wood finish, at \$399.95; and model 7P3, 17-inch TV-Phono combination in bleached mahogany modern styled cabinet with



two-thirds doors, at \$429.95. Majestic Radio & Television, Division of The Wilcox-Gay Corp., 70 Washington St., Brooklyn 1, N. Y.—RADIO & TELEVISION RETAILING.

Duosonic PHONO

The model 98, shown here, is a 3-speed phono attachment designed to



give the appearance of a "Jewel Box". The lid is gold embossed. Equipped with plug-in jack for playing through radio or television set. Employs a universal all-purpose, all-speed needle. Sonic Industries, Inc., 221 W. 17 St., New York, N. Y.—RADIO & TELEVISION RETAILING.

Sell the line that fits every family need!



SMALL FRY



HOPALONG CASSIDY RADIO **17⁹⁵**
Biggest HIT in radio history!

Kids, parents, aunts and uncles—and DEALERS—are raving about this smash hit Hoppy set! Real big-performance AC/DC superhet; shatter-proof cabinet shows Hopalong and his horse; complete free promotion kit with 12 sets!

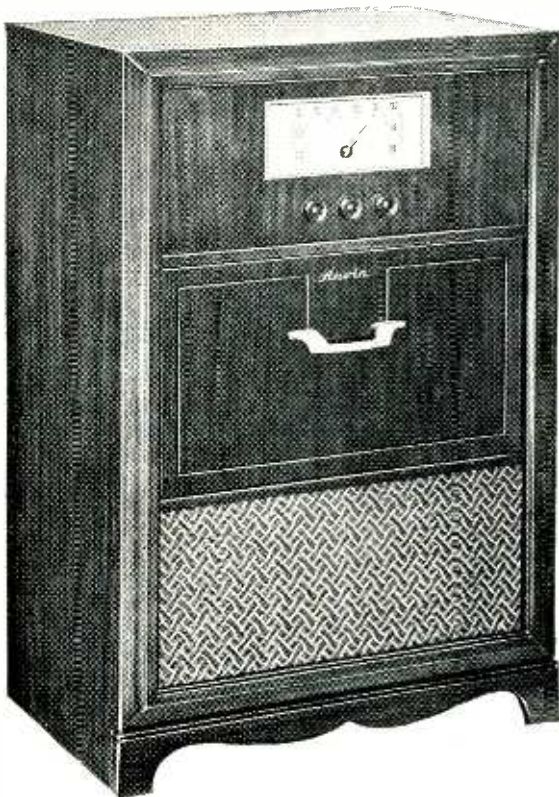

BEST BUY IN PHONO-RADIO COMBINATION

Model 462-CM—Superb mahogany finish console with 6-tube AM radio and 3-speed automatic record changer for 33, 45, 78 rpm records. Shuts off after last record. Year-round pleasure for the whole family!.....

Model 482-CM—FM/AM radio console combination, \$159.95 **139⁹⁵**

All prices subject to change without notice



MOTHER



HER OWN PERSONAL RADIO **37⁹⁵**
Solves Dad's shopping problem!

Model 460-T — She'll love the long, low lines of this beauty and the fine 6-tube performance it gives. 3-gang condenser; tuned stage of rf; exclusive Velvet Voice tone; lighted lucite dial; in Ivory, Willow Green, Sandalwood plastic finish.

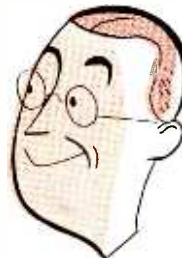

DAD



PEAK VALUE IN PORTABLES **39⁹⁵**
Just the set for winter vacationers

Model 350-P—The finest 3-way portable buy of the year! Packed with power, performs everywhere! AC, DC, or battery. Kingfisher Blue, Jade Green, Sun-Tan, or Burgundy. Weighs only 6 lbs. (Price less batteries)



AUNT MABLE

Write, Wire, or Phone for Distributor's Name
Television and Radio Division
ARVIN INDUSTRIES, Inc.
Columbus, Indiana

(Formerly Noblitt-Sparks Industries, Inc.)



Television & Appliance Retailing

Section of RADIO & TELEVISION RETAILING

This and following pages describing manufacturers' new merchandise are compiled by our editors. This information is presented as a news service to our readers entirely without any advertising consideration whatsoever.

Gibson NEW LINES

The new refrigerator line is called "Full Length Feature" design. It includes two 9 cu. ft. models with full length doors and full length interior design. Model 941, including Freez'r Locker and Fresh'ner Compartment, lists for \$289.95. Model 981, similar model with built-in door racks, lists at \$309.95. The three new 11 cu. ft. models include model 1131, with built-in Touch-a-Tap feature for providing cold drinking water, at \$379.95; model 1151, shown here, with toe operated door, at \$399.95; and model 1101, at \$259.95. Two new full length 7 cu. ft. models are the 701, at \$199.95, and the 721, at \$229.95. Both available with right or left hand doors.



Six new electric ranges include model H, with two ovens, seven speeds for surface and deep-well cooking, at \$399.95; model A-4, including four surface units and appliance outlet, at \$169.95; model C, including 6 qt. Kook-all, at \$199.95; model D, with similar features, at \$259.95; model E, including full width fluorescent light, at \$359.95.

Two new home freezers are the model HF1000, 360 pound capacity, at \$319.95, and the model HF1890, 18 cu. ft. model with 630 pound capacity, at \$519.95. Both models carry a five-year service warranty. Gibson Refrigerator Co., Greenville, Mich.—RADIO & TELEVISION RETAILING.

Markel HEETAIRE

Wall insert radiant Heetaires of 1000 to 1250 watts, with built-in thermostats, have been announced. Designed to automatically produce and maintain any desired temperature between 40° and 85° F. Thermostat automatically turns Heetaire on and off as needed. Mounting boxes for the heaters are packed separately and may be ordered in advance for installation while rough work is still in progress. 1000 watt unit is model 241T, 1250 watt unit is model 246T. Both models are finished in polished Nuchrome or ivory enamel. Both operate on 115 volts AC. Markel Electric Products, Inc., Buffalo, N. Y.—RADIO & TELEVISION RETAILING.

Magnavox MODERN THEATRE

Called the "Modern Theatre", this new TV model features a 19-inch picture tube. Includes a built-in phono jack for record playing. List price is \$495. Available in modern blond or



traditional mahogany finishes. Magnavox Co., 2131 Beuter Rd., Fort Wayne 4, Ind.—RADIO & TELEVISION RETAILING.

GE GARBAGE DISPOSER

A completely redesigned General Electric garbage disposer which is more economical to operate and 50 per cent quieter than previous models has been announced. It incorporates a new shredding mechanism. Operated by turning on cold water tap. Approximately 15 pounds lighter and somewhat smaller than previous models, the two new models (FA-4 and FA-41) have the same food waste capacity. Both models list for \$124.95. General Electric Co., Appliance & Merchandise Dept., Bridgeport 2, Conn.—RADIO & TELEVISION RETAILING.

Litmaster TV LAMP

Called the Litmaster television fluorescent lamp with Telechron clock, this new lighting unit is 10½" high, 5" x 8" base. The light is furnished by standard 15-watt T8 fluorescent tubes. Designed to provide no-glare illumination for video reception. Available in statuary bronze or warm gray finish with brass trim and also decorator col-

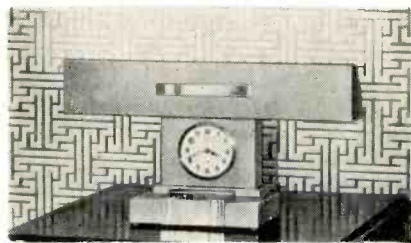

ors. Telechron clock has 3½" diameter. List price is \$15.00. Art Specialty Co., 3245 W. Lake St., Chicago 24, Ill.—RADIO & TELEVISION RETAILING.

Admiral 14" TV SETS

Two new TV sets, both with fourteen-inch picture tubes, have been introduced. The sets, a table model and a



console, are both priced under \$200. The table model, shown here, measures only 1½ feet square. Cabinet is finished in mahogany plastic. Console cabinet is also mahogany plastic. Both sets feature bevelled screen escutcheons. Admiral Corp., 3800 Cortland, Chicago, Ill.—RADIO & TELEVISION RETAILING.

Sewmatic PORTABLE SEWING MACHINE

Featuring a simplified, streamlined modern design, this portable electric sewing machine lists for \$49.95. A luggage type case is available at extra cost. Moving parts are completely enclosed in an aluminum housing with



only the sewing head and plastic fly-wheel exposed. Total weight of the machine is 11½ pounds. The Sewmatic makes an elastic stitch with a single thread and each stitch is individually tightened. There is no bobbin. Variable foot control governs speed. Machine carries a 5-year warranty. Erie Products Company, Park Avenue Bldg., Detroit, Mich.—RADIO & TELEVISION RETAILING.

REPLACEMENT OR REFUND OF MONEY
 ★
 Guaranteed by
 Good Housekeeping
 IF NOT AS ADVERTISED THEREIN

GRANTED TO...

RAYTHEON TELEVISION

ANOTHER PROOF OF RAYTHEON DEPENDABILITY!



THE MAFGUIS
 Model C-1714

As Advertised in *Life*, *Good Housekeeping*,
Saturday Evening Post

BELMONT RADIO CORPORATION
 5921 W. Dickens Avenue, Chicago 39, Ill.
 Subsidiary of RAYTHEON MFG. CO.

You know how important that GOOD HOUSEKEEPING guaranty seal is . . . what thorough testing a product must go through before it is guaranteed as advertised in GOOD HOUSEKEEPING. Now—that famous seal is granted to the entire line of RAYTHEON television sets!

It's another proof of the dependability of Raytheon. And no wonder! Every Raytheon set is precision engineered . . . made of top-quality parts and materials . . . to give outstanding performance. Raytheon uses no short cuts—leaves out no parts—in order to cut prices. All reasons why you can place full confidence in Raytheon!

See the beautiful new models now available in the 1951 Raytheon line. Every one is dependably built for dependable performance!

List Prices Range from \$189.95 to \$625.00

Here's Plus Proof That Every Raytheon Set Is...



Backed by a liberal
 One-year Warranty!



Backed by the Under-
 writers' Laborato-
 ries Seal!



Made by a leader in
 electronics for 25
 years!

Dependably Built for Dependable Performance

YOUR CONNECTIONS ARE IMPORTANT!



Spring Action

PLUGS & CAPS
Replacement, "Cord Clamp"
& Manufacturers' Assembly Plugs



Tapmaster
CUBE TAPS
One-Piece Rubber
and Bakelite

Tapmaster INDESTRUCTIBLE, SOLDERLESS, 3-WAY EXTENSION CORD SET
MASTERS INTERNAL BRUSH STRIKE UP PLUGS
CONNECTION OF PLUG AND STRIKE ALICE

IN THIS CUBE OUTLET:
Three positive plug-holding outlets in the anodized, unbreakable, cast rubber service block. Can be stepped on without damaging or dislodging connected plug because of heavy rubber construction.

ONE THEN NOTE:
Spring-Action Plug will make Perfect Positive Contact in any outlet. Special solderless internal connections of wire to plug and service block prevent pulling and sagging of wire with no damage to cord let. Strain Relief!

Tapmaster EXTENSION CORD SET
Irvington, N. J., U. S. A.

ALLIED ELECTRIC PRODUCTS, INC.
WORLD'S LARGEST MANUFACTURERS OF ATTACHMENT PLUG CAPS

THE FIRST EXTENSION CORD SET ENGINEERED FOR PERMANENT EFFICIENCY

THE CAT. NO. 310

Tapmaster
EXTENSION CORD SETS
3-Way & Single-Outlet Types
6', 9', 12', and 15' Lengths

Poor contact between line plug and wall outlet can cause a heap of trouble in a T-V set or radio. A defective plug or worn outlet can produce voltage drop and arcing . . . and you know what that means to a set.

Take that ounce of prevention! Replace the line plug with a genuine Spring-Action Replacement Plug—the sure way to be sure of positive contact even in a worn outlet. If you need a multiple outlet, use a Tapmaster Cube Tap. Or, if the line cord needs lengthening, use a Tapmaster Extension Cord Set. These products have Spring-Action Blades and Internal Contacts. With them, you'll get good connections any place, all the time. MR. SERVICEMAN—Save yourself unnecessary service calls. Carry these three connections in your kit. Your jobber can supply them to you.

YOU CAN DEPEND ON THESE OTHER

ALLIED-SHELDON PRODUCTS

FLASH
Sheldon

FLUORESCENT STARTERS

World's Largest Line—
Automatic Cutout . . . Push-Button
. . . Multi-Purpose . . . No-Blink
. . . Standard Types



Sheldon
2, 6 and 15 Amps.
RECTIFIER BULBS

Sheldon

ALUMINIZED REFLECTOR LAMPS

Infra-Red, Flood, Spot, Clear,
Photoflood, Photospot, 2,000
Hour & Outdoor Pyrex Types

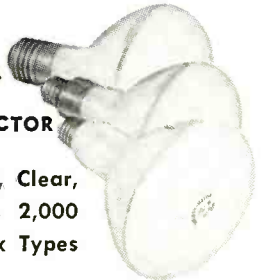

WRITE FOR YOUR COPY OF THE NEW ALLIED-SHELDON CATALOG
DELIVERY ON ALL ITEMS ON THIS PAGE — *Fair to Middlin'!*

ALLIED ELECTRIC PRODUCTS INC.

68-98 Coit Street, Irvington 11, N. J.

Branch Offices & Warehouses: CHICAGO 7, ILL., 426 S. Clinton St. — LOS ANGELES 26, CAL., 1755 Glendale Blvd.

IT'S NEW...

IT'S

Miles!

it
MOVES
fast

and we do mean off your floor!



Model 428-CVM—Mahogany
Also colorfast Blond—Model 428-CVB

Every *Sentinel* you sell today means happy, satisfied customers—customers who will endorse *Sentinel* to their friends and neighbors, build more sales for you next February, March or July when you will need them. Watch *Sentinel*, it's *alive* and will continue to climb when the "dogs" are dropping out right and left.

Alive with quality that stands up—*alive* with beauty that endures—*alive* with features that mean fast sales against any competition, plus long lived satisfaction for your customers—yes, *Sentinel* is *alive* with interest for *live* dealers who want to stay alive when the present "gold rush" is over!

Write TODAY—we'll PROVE how *Sentinel* is, and shall continue to be, thoroughly alive to your prosperity!

Sentinel
Television Sets
Snub
Service Calls!

**TRULY
AUTOMATIC
TUNING!**



**SENTINEL RADIO CORPORATION
EVANSTON, ILLINOIS**

Easy-to-Make Xmas Displays

A few simple ideas for constructing your own Christmas displays, as suggested by the lamp department of General Electric, are shown here. Many attractive and inexpensive effects can be had by various applications of these and other easily-devised displays.

Trees

STYLIZED

Cones or Half-cones Translucent
Colored or inside-frosted lamps
Wire cones to center pole
Outlet box
With opaque material, locate lamps around inside lower edge of each cone
Wire frame or flat background
Festoons or colored lamps
Tubular or Lumiline lamps
Clear lamps for flame
Crinkled colored foil or composition board
150 W PAR 38 floodlights
Back of candle slits on front tree covered with translucent material
Tubular or Lumiline lamps
Amber or clear lamps
Crinkled silver foil with colored lamps
Composition board or crinkled colored foil
Colored Lamps
Foil reflector
Composition board - colored
Can be flat or 3-sided
Sockets behind board
Floodlight
Colored lamps
TOP VIEW

Stars

Composition board painted or covered with aluminum foil
Metal cap or painted
Socket
Support
Translucent face Plastic or Cel-o-glas
Opaque or translucent shield
Wood or Composition board backing
Center Lamps
Small clear lamps at points
Metal or Composition board
Cardboard
Tracing cloth
Cel-o-glas or parchment paper
INTERIOR USE ONLY
12" & 18" Lumiline lamps on wood strips
Clear lamp
Clear or colored lamps
Lumiline Lamps
Painted White
Wood
Composition board painted white
Wood background

Bells

Translucent
Plastic
Tubular showcase lamp
Smooth foil
Colored Cellophane
Wire guard attached to socket
Silvered bowl lamp clapper
Spacers for sections
Lucite or Plexiglas sections - Edges sanded
Tubular showcase lamp
SECTION
Composition board, Foil covered Cardboard or Corrugated Display papers, etc.
Opaque
Bottom covered with muslin or tracing cloth
White or colored lamps in base
Crinkled foil

Candles

Row of clear or colored lamps - can be tubular
Clear or inside-frosted lamps
PAR 38 Projector Spot Lamps
Plastic or Cel-o-glas
Wood or composition board painted white
Clear Lamp
Lumiline lamps
Background flat, corrugated or foil
PAR 38 Projector spot lamps
Half of cardboard cylinder painted with design
TRANSLUCENT
REFLECTING

Wreaths

White background composition board
Green shields
Wire supports
Foil or Plastic
Wood or composition board with colored lamps
Composition board or wood
Painted grey
Metal cap or painted
Foil covering
Colored Lamps
Crinkled foil, green or silver
Spotlight White or Green

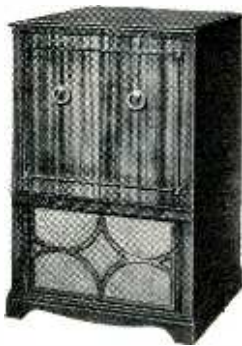

19" TV CONSOLE
THE CARNEGIE. Turns shoppers into buyers. Nonglare 19" black tube. Model 5085, mahogany; 5086, blonde. \$429.95 Mahogany

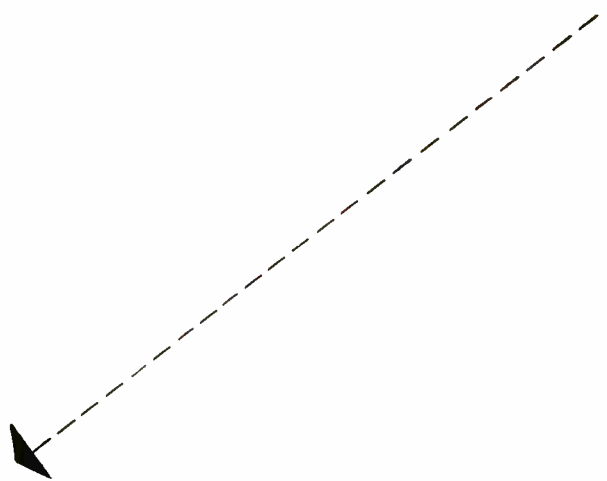

SCMP



17" TV, RADIO, PHONOGRAPH
THE NASSAU. Champion in styling, value. Big 17" black-tube TV, AM-FM radio, 3-speed automatic record player. Model 5082, mahogany; 5083, blonde. \$459.95 Mahogany

— more valuable than ever

In these days of set and component part shortages, plus inflated consumer demand, Sparton dealers are reaping real benefits from the SCMP—Sparton Cooperative Merchandising Plan.

For under SCMP all of Sparton's production goes fairly and exclusively to its relatively small group of dealers at protected prices.

In short, the tougher the sledding, the more valuable the Sparton franchise, because it works for Sparton dealers.

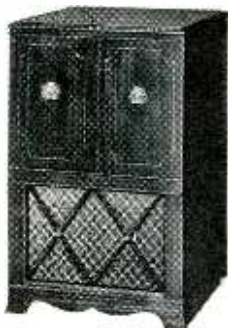

17" TV CONSOLE
THE ARDMOOR. Extra performance, extra beauty, extra value! Full 17" rectangular black tube. Model 5079, mahogany; 5080, blonde. \$319.95 Mahogany

NATIONALLY ADVERTISED IN *LIFE* AND *NEWSWEEK*

Radio-Television's Richest Franchise



17" TABLE-MODEL TV
THE BELMAR. Trim, smart table model with 17" rectangular black tube. Model 5025, mahogany; 5026, blonde. \$249.95 Mahogany



TV Spearheads Sales

Ups Volume in Other Products, Boosts Servicing for Dealer in Illinois Fringe Area

• The Ken Price Radio & Television Co., 115 No. 4th. St., Watseka, Ill., put itself on the local television map by employing a number of unique sales and advertising ideas, and by gaining a reputation for good servicing and maintenance.

To begin with, everybody in Watseka, a town of 5,000 population, with a trading area of about 30,000, can see the name "Price" on the 85-foot tower, brilliantly illuminated at night. This sign helps compensate for the side-street location of the store. TV sets, operating in the show-window, draw nightly audiences.

There's plenty of advertising value, too, in the demonstrations made with a trailer carrying a telescoping mast, having a maximum height of 51 feet, to bring in good pictures in this fringe territory, 85 miles south of Chicago. Last, but certainly not least, the Price store obtains a volume of valuable

word-of-mouth advertising from satisfied customers, and keeps its name in the public eye through newspaper advertising, and participation in local civic events.

Sales-wise, the firm features free home demonstrations, developing 99 out of a hundred trials into purchases. Quite often such transactions involve traveling considerable distances, making it necessary for the Price organization to check financial standing, etc., of would-be purchasers before agreeing to a demonstration.

Another sales technique that works out very well is the merchandising of a complete TV installation as a package unit, including the set, booster, and antenna set-up. The various units are not quoted separately, but are sold for a lump sum. Almost all sales are on a cash basis.

The radio service department is kept
(Continued on page 96)

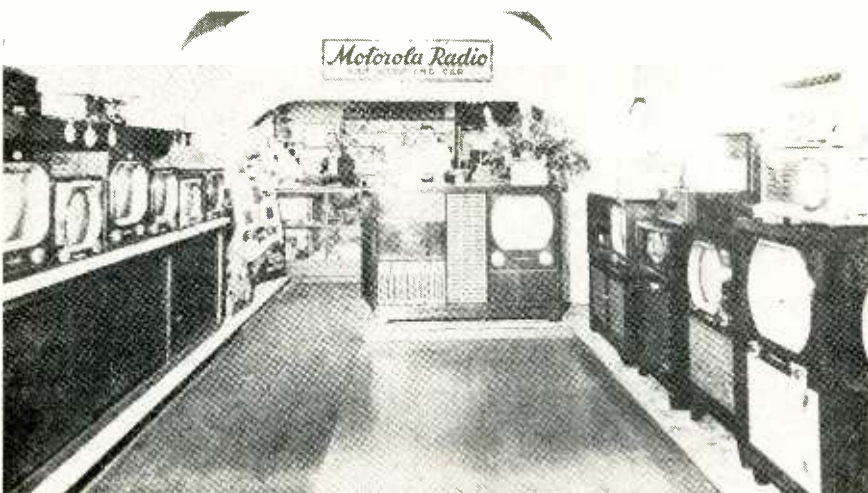

Out-front service department helps boost reputation of this young Illinois firm. In new store, to be built soon, a 50-seat TV "theater" will be featured.

Attractive display piece serves as a table model "bar." 20 to 25 live demonstrators are on tap at the Ken Price store, Watseka, Ill.

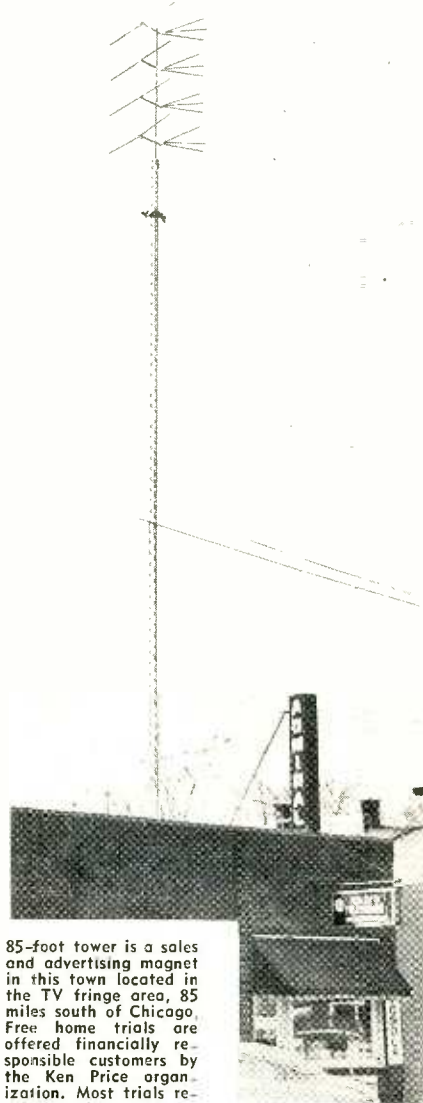

85-foot tower is a sales and advertising magnet in this town located in the TV fringe area, 85 miles south of Chicago. Free home trials are offered financially responsible customers by the Ken Price organization. Most trials result in sales.

Dealer Price Uses:

- Conical-type antenna for best all-round reception.
- 4-stack straight dipole antenna for best low-channel reception.
- Shielded lead (RG11U) for better signal to noise ratio.
- Amplified antenna distribution system in store so that all sets can be demonstrated simultaneously.

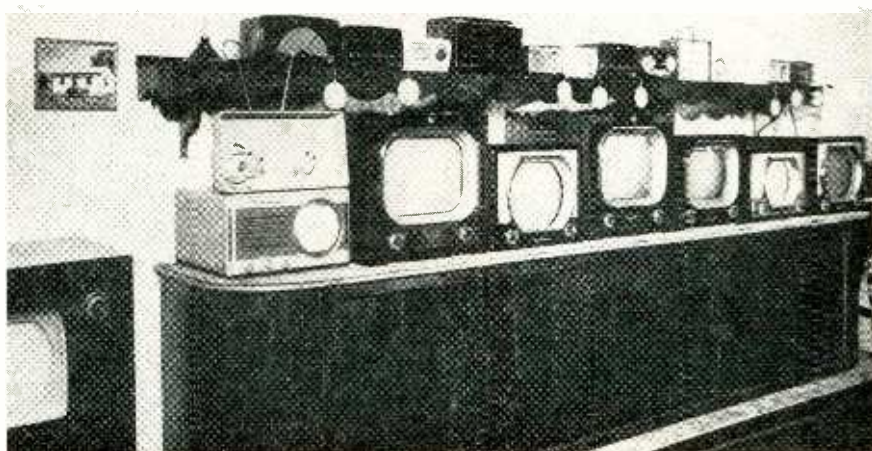

ZENITH ANNOUNCES

2 Super-Sensitive FM-AM Radios with Performance Superiority that makes Sales!

Again Zenith lengthens its lead over the FM-AM field—with new and better versions of the Zeniths that were already the industry's two best sellers. With Zenith's unrivaled Super-Sensitive FM, they bring in a wealth of entertainment,

static-free and real as only genuine FM can be. Their newly designed cabinets are the style highlights of the radio year. Of course, both have Zenith's famous Long Distance AM, big Zenith-built Alnico speakers and other Zenith advantages.



New Super-Medallion

Genuine Super-Sensitive Zenith-Armstrong FM plus Zenith Long Distance AM—automatic volume control—built-in Wavemagnet* and Light-Line Antenna—cabinet of beautiful maroon plastic with Roman Gold mesh grille and tuning indicator.



New Super-Triumph

The same Super-Sensitive FM and Long Distance AM as the Super-Medallion, plus new broad-range tone control—jewel-like on/off indicator—maroon plastic cabinet with "Flexo-Grip" carrying handle—Roman Gold embossed dial.

Zenith is No. 1 for '51!

ZENITH RADIO CORPORATION, CHICAGO 39, ILLINOIS
 Over 30 Years of "Know-How" in Radionics Exclusively
 ALSO MAKERS OF AMERICA'S FINEST HEARING AIDS



Huge TV Volume in 4 Years!

• Television Company of Maryland, with headquarters at 115 W. Fayette St., Baltimore, is less than 4 years old, but it now has four stores in Baltimore, three "subsidiary" stores which are not under the Television Company of Maryland name; employs more than 80 people; did a two-million dollar volume of business last year, and spent \$250,000 in advertising and sales promotion.

35-year-old Milton Rabovsky is the sparkplug back of this big business. He worked hard to reach the high sales volume the firm now enjoys, and he isn't relaxing his efforts in the least. Far from resting on his laurels,



(Above) At Friendship International Airport, the mayor of Baltimore, Thomas D'Alesandro, presents television receivers donated by TV Company of Maryland to doctors from Children's Hospital and Kernan's Hospital. (Below) When the Lion's held a parade in Baltimore, Television Company of Maryland was on hand with its travelling show-room.

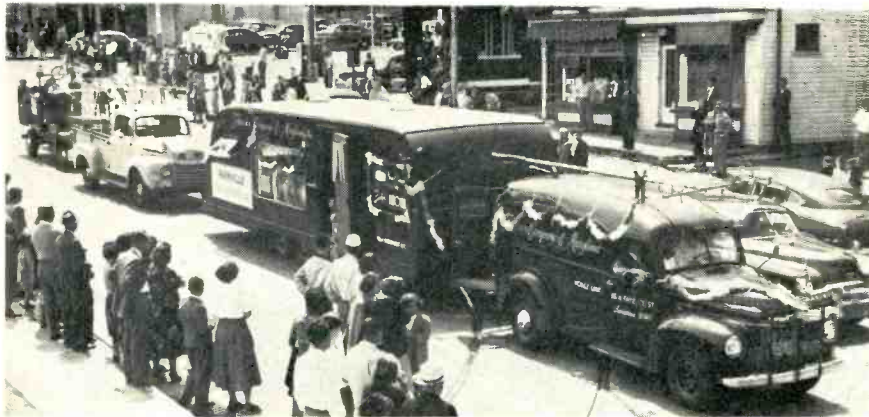

Rabovsky puts in 15 to 18 hours a day. He buys all the merchandise, sells on the floor, trains salesmen, and is available on the telephone and in person to anyone who wants to see him about anything connected with television.

Perhaps the greatest factor in the firm's success is the dynamic sales promotion program which is carried out consistently by a staff of expert merchandisers and paid for out of sales revenue which is plowed back into the business. The firm advertises in newspapers, local magazines, shopping newspapers, and on radio and TV. When WAAM-TV in Baltimore went on the air, their first sponsor was Television Company of Maryland. They have tied in actively with sports in Baltimore, using full-page ads in the Baltimore Colts' football programs. The firm uses many radio spots in connection with local and national sports events, and sponsors at least one radio or TV show each week.

Salesmen are thoroughly trained,

and earn good money on a draw against commission-plus incentive bonus plan. All brands of TV are sold.

The firm has its own art depart-

ment where special display material is made to order. Displays in stores and in show-windows attract lots of attention. A recent show-window set-up displayed receivers, signs, banners, etc. at odd angles, with one big sign reading "We Know All the Angles."

The service headquarters and warehouse is located at 2200 Sherwood Ave., Baltimore, in a 6,000 square-foot, one-story building.

Rabovsky lends himself to a number of community activities. Practically everyone in Baltimore who discusses TV knows about "Mr. Milton".

The vice-president of the firm is Joseph Hoffman, a prominent Baltimore business man. Clayman Campbell is the general sales manager, and Edward Sherwood doubles as manager of the West Fayette Street store and promotion manager.

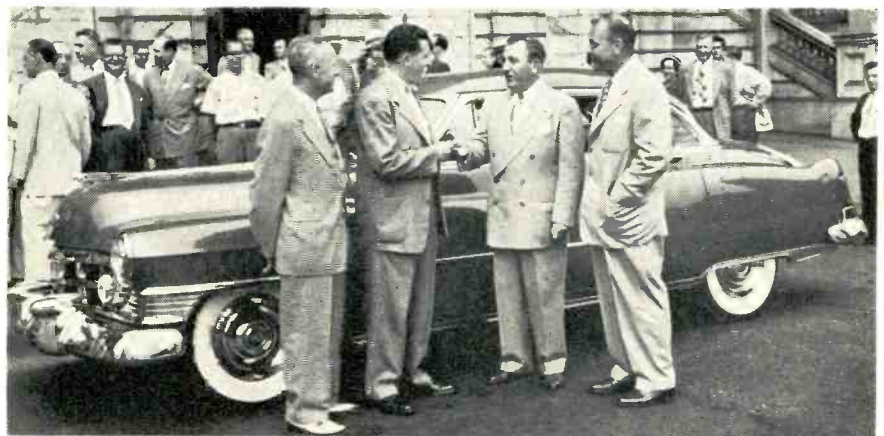

(Above) Television Company of Maryland won first prize in the DuMont promotion contest for the best overall promotion on the 19" Hanover. In this photograph, the prize, a 1950 Cadillac, is being presented to Milton Rabovsky. Left to right: Joseph Hoffman, TV Company of Maryland, Milton Rabovsky, Mayor D'Alesandro, and Walter L. Stickel, DuMont sales manager. (Below) Fleet of service cars and trucks maintained by TV Company of Maryland.



To make your sales program more effective, and,
as an accurate indication of the greatest
television market potentials . . .

THOMAS ELECTRONICS INCORPORATED

presents the

1951 Television Map
with
Associated Market Data

THOMAS ELECTRONICS

1951 TEL

INCORPORATED
118 Ninth Street Passaic, New Jersey

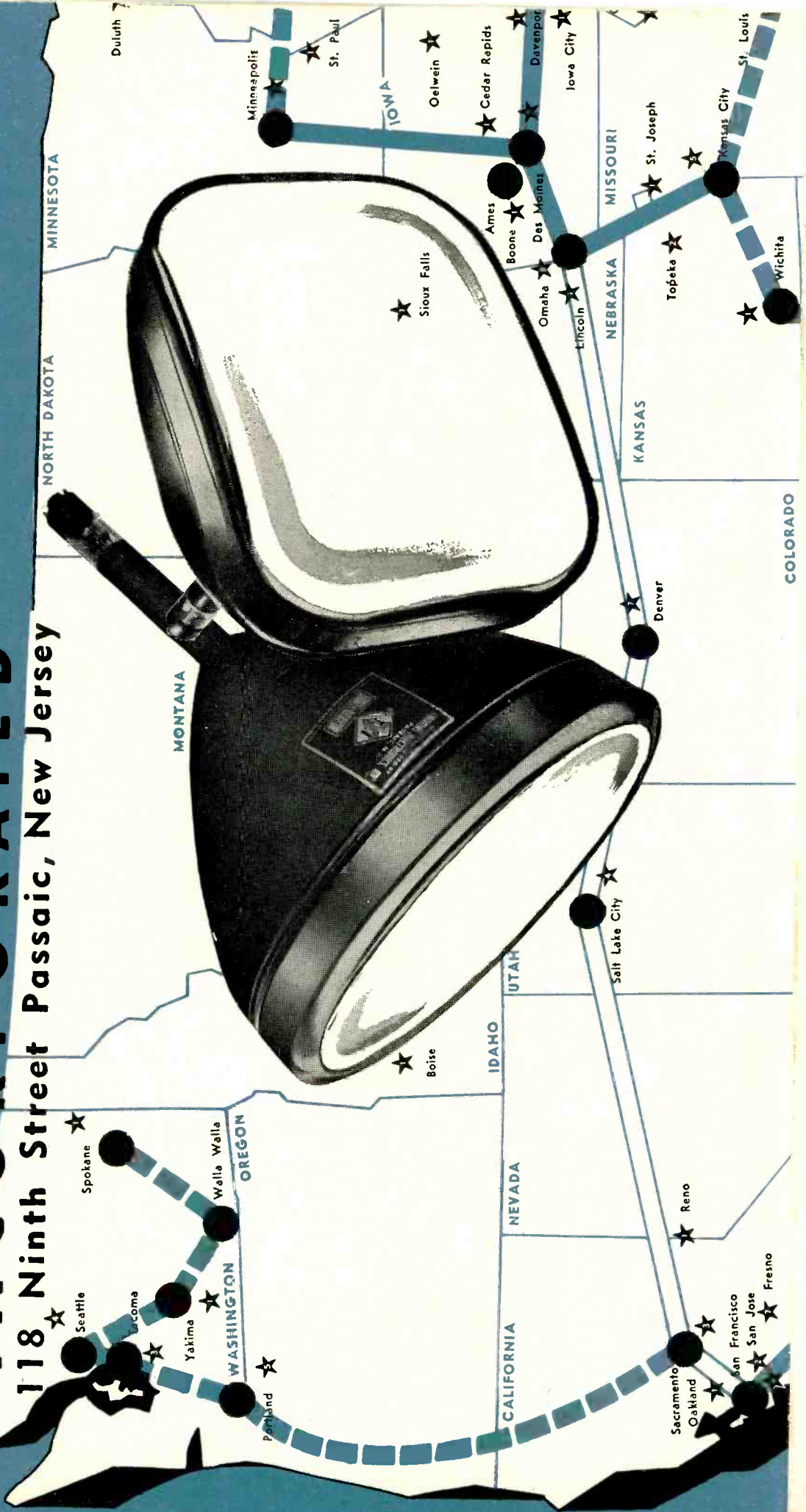

New Replacement Parts and

Stancor LINE ADJUSTER

A new series of line adjusting Xformers include four units which permit operation of electrical devices at 115 volts when the supplied voltage is 65, 75, 90, 100, 115, 130 or 145. They meet power requirements up to 750 VA, 50/60 cps. Input is correctable in 7 steps by



means of a selector switch and indicated by an output voltmeter. These units are also useful for altering a 115-volt line above or below that level. Standard Transformer Corp., 3580 N. Elston Ave., Chicago 18, Ill.—RADIO & TELEVISION RETAILING.

Spellman OPTICAL BARREL

A Schmidt optical barrel for projection TV is available to produce pictures up to 6 x 8 feet. Images may be varied in size by a control on the barrel. For smaller images, the optical system is



available with a different lens. Barrel dimensions are 17" high, 13" dia. Spellman Television Corp., 3029 Webster Ave., Bronx 67, N. Y.—RADIO & TELEVISION RETAILING.

Porter IMPAKDRIVER

With a twist in the desired direction and a few raps with a hammer, screws, bolts or nuts can be tightened or loosened quickly with a new hand tool called "Impakdriver." Particularly designed for stubborn nuts, bolts or screws that have rusted or frozen on, and for hard-to-reach places. Impakdriver is sold by itself or in sets with different combinations of bits and sockets. H. K. Porter, Inc., Somerville, Mass.—RADIO & TELEVISION RETAILING.

Clarostat VOLTAGE REGULATOR

Designed for steadier TV pictures regardless of line-voltage fluctuations, the Automatic Line-Voltage Regulator has male and female connections at opposite ends and plugs between the TV set line cord and the electrical outlet. Model TV-A is rated at 300 watts and TV-B at 375 watts. Clarostat Mfg. Co., Inc., Dover, N. H.—RADIO & TELEVISION RETAILING.

Phillips CABLE TACKER

Designed for radio men, sound men and juke box installers, the cable tacker features concave center guides that instantly center both small and large

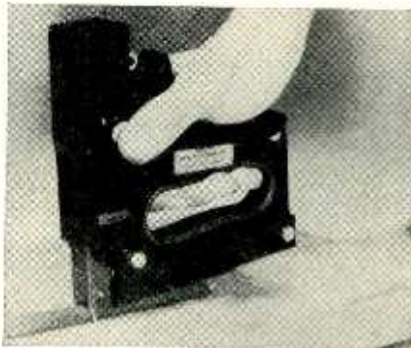

cables. Tacker handles staples in 3 lengths: 3/8", 1/2" and 9/16". Will handle cable up to 1/2-inch OD. Phillips Mfg. Co., Minneapolis, Minn.—RADIO & TELEVISION RETAILING.

Johnson TIP JACKS

New tip jacks are designed for longer life and better service. Contact is made along the entire length of the phone tip or test prod and is said to remain unchanged despite insertion of oversize tip, excessive binding forces, or long use. Jacks are available in insulated type with molded Plaskon heads in 10 colors, or without head for mounting directly in equipment. E. F. Johnson Co., Waseca, Minn.—RADIO & TELEVISION RETAILING.

RCA AMPLIFIER

Type MI-12160 is a plug-in line amplifier with self-contained power supply for use in custom sound installations. It can be used as a master mixer for up to 4 preamps, a booster amplifier for supplying zero db level to telephone lines, a line amplifier for operating from a telephone line, a driver amplifier for up to 500 power amplifiers, a monitor amplifier supplying 2 watts to a speaker, or a bridging amplifier for bridging a low impedance line. In addition it can supply plate and filament power to 2 preamps. Response is 30-15,000 cps, output up to 2 watts. Sound Products Section, RCA Engineering Products Dept., Camden, N. J.—RADIO & TELEVISION RETAILING.

Sylvania CRT TESTER

Cathode ray tube testing adapter type 228 is designed to test TV picture tubes without removing from set, and to indicate shorts, leakage and open heaters in electro-magnetic CRT's, and will also



indicate relative emission if types have accelerating anodes. The 228 is used in conjunction with a Sylvania tube tester. Sylvania Electric Products, Inc., Emporium, Pa.—RADIO & TELEVISION RETAILING.

Eico TUBE TESTER

Model 625-CK is a tube tester kit designed for counter display. Individual switches are provided for testing every tube element; 4, 5, 6, 7, octal, loctal, noval, VR, magic eye and pilot bulbs can be tested. Illuminated roll-chart,



2 grid caps and protective overload bulb are included. Price for kit is \$44.95, or completely wired for \$59.95. Electronic Instrument Co., Inc., 276 Newport St., Brooklyn 12, N. Y.—RADIO & TELEVISION RETAILING.

Molly SCREW ANCHORS

Screw anchors are available in 8 sizes for mounting fixtures on hollow walls or ceilings such as wallboard, plaster, plywood, hollow tile, building block, etc. Light machinery, fuse boxes, shelves, signs, cabinets, etc., may be mounted to floors, ceilings, hollow blocks or metal walls. Expanding anchor behind wall secures screw. Molly Corp., Reading, Pa.—RADIO & TELEVISION RETAILING.

New Aids for TV Technicians

Electro DISTRIBUTION SYSTEM

The TVD-8 TV antenna distribution system is designed to enable TV dealers to demonstrate from one to eight TV receivers from a single antenna. It may be used on all 12 channels, and pictures from several stations can be shown to different customers at the same time. Self-powered, the unit provides balanced 300 ohm input and output. Maker states there is no interaction between receivers and other sets are not affected by a short or open at the connection of any one set. The TVD-8 may also be used in small apartments and multiple dwellings. Electro Engineering and Mfg. Co., 627 W. Alexandrine, Detroit, Mich.—RADIO & TELEVISION RETAILING.

Video INDOOR ANTENNA

Model Vi-A indoor antenna for TV is non-directional and is of flat, one-plane construction. It can be hidden beneath the carpet, back of a drapery or behind a picture on the wall. It is provided with

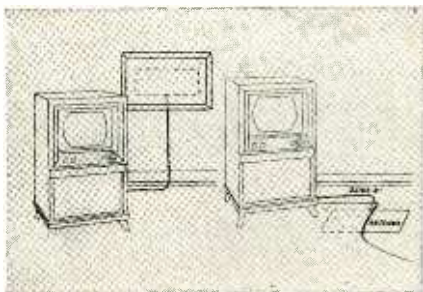

either opaque or transparent lead-in. Excellent reception is said to have been obtained in apartments. Video Associates of Toledo, 1823 Adams St., Toledo 2, Ohio.—RADIO & TELEVISION RETAILING.

U.S. Devices ROTATOR

The "Compass Point Indicator" is now available with this firm's TV antenna rotators. The unit features a full 360 degree dial which is said to be the clearest and largest on the market.



Model 501-A is priced at \$34.95, and model 503 (indicator shows exact position of antenna) lists at \$44.95. U. S. Devices Corp., Hillside Ave.-Oaktree, South Plainfield, N. J.—RADIO & TELEVISION RETAILING.

Masco TV BOOSTER

The new "Sky Chief" is said to help reduce noise and interference and to aid in eliminating ghosts and snow. Housed in a mahogany finish metal cabinet with sloping front, it has only one control to tune from channel 2 to 13.



It turns itself on and off with the TV receiver. U/L approved, the Sky Chief lists for \$32.50. Mark Simpson Mfg. Co., Inc., 32-28 49th St., Long Island City 3, N. Y.—RADIO & TELEVISION RETAILING.

Trio YAGI ANTENNA

A new 2-channel yagi type antenna is available for channels 4 and 5 in the low band or channels 7 and 9 in the high band. The maker states this antenna has high front-to-back ratio and low weight per gain and can be used

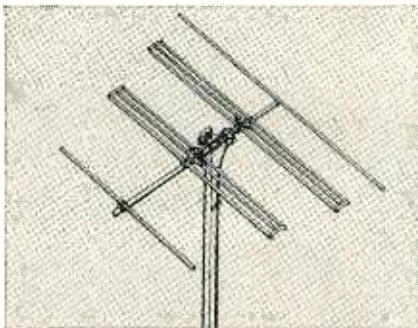

with 300-ohm line. The antenna may be had as single bay, conventional 2-bay, or Trio 2-bay offset stacked array tuned with the Trio "phasitron" for eliminating co-channel interference. Trio Mfg. Co., Griggsville, Ill.—RADIO & TELEVISION RETAILING.

Oak Ridge TV ANTENNA

The "Beam Master" is a new V-type antenna designed for noise reduction reception on all channels. Elements are reinforced with a dowel on one end and pressure sealed on the other end. All-channel reception is provided with a good match for 300-ohm line, and quick assembly is provided for in the construction. Oak Ridge Products, Div. Video Television Inc., 239 E. 127 St., New York 35, N. Y.—RADIO & TELEVISION RETAILING.

Telrex TV ANTENNAS

The "Monarch" series is designed to combine the versatility of the Telrex "Universal" models with the constructional and electrical features of the "De Luxe" series. Designed for all-channel performance, the Monarch is available in single, double and 4-bay models as K2X-TV, K4X-TV, and K8X-TV. Telrex, Inc., Asbury Park, N. J.—RADIO & TELEVISION RETAILING.

Vee-D-X ARRESTER

Model RW-204 lightning arrester for TV is designed to accommodate 4-wire rotator line as well as regular 300-ohm transmission line. The arrester is con-

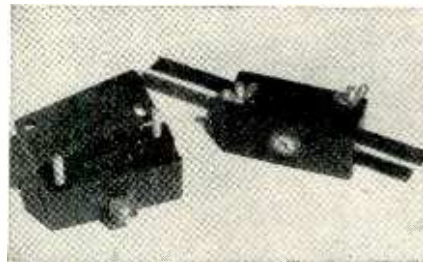

structed of high dielectric double phenolic. Firm states that the RW-204 is UL approved. LaPointe Plascomold Corp., Unionville, Conn.—RADIO & TELEVISION RETAILING.

Tennalab TV ANTENNA

"Gemtenna" is a 5-element yagi type antenna designed for fringe reception. Of aluminum construction, the antennas include a matching section which adjusts 75 to 300 ohms. Models are available for each of the 12 channels. Gemtennas of similar channel may be stacked for additional gain. List prices range from \$20.00 (channel 13) to \$37.50 (channel 2). Tennalab, Quincy, Ill.—RADIO & TELEVISION RETAILING.

Alliance TENNA-ROTOR

The original deluxe model Tenna-Rotor control case, which is fully automatic, is now supplied with a North-



East-South-West direction indicator dial. The new model is designated model HIR. Alliance Mfg. Co., Alliance, Ohio.—RADIO & TELEVISION RETAILING.

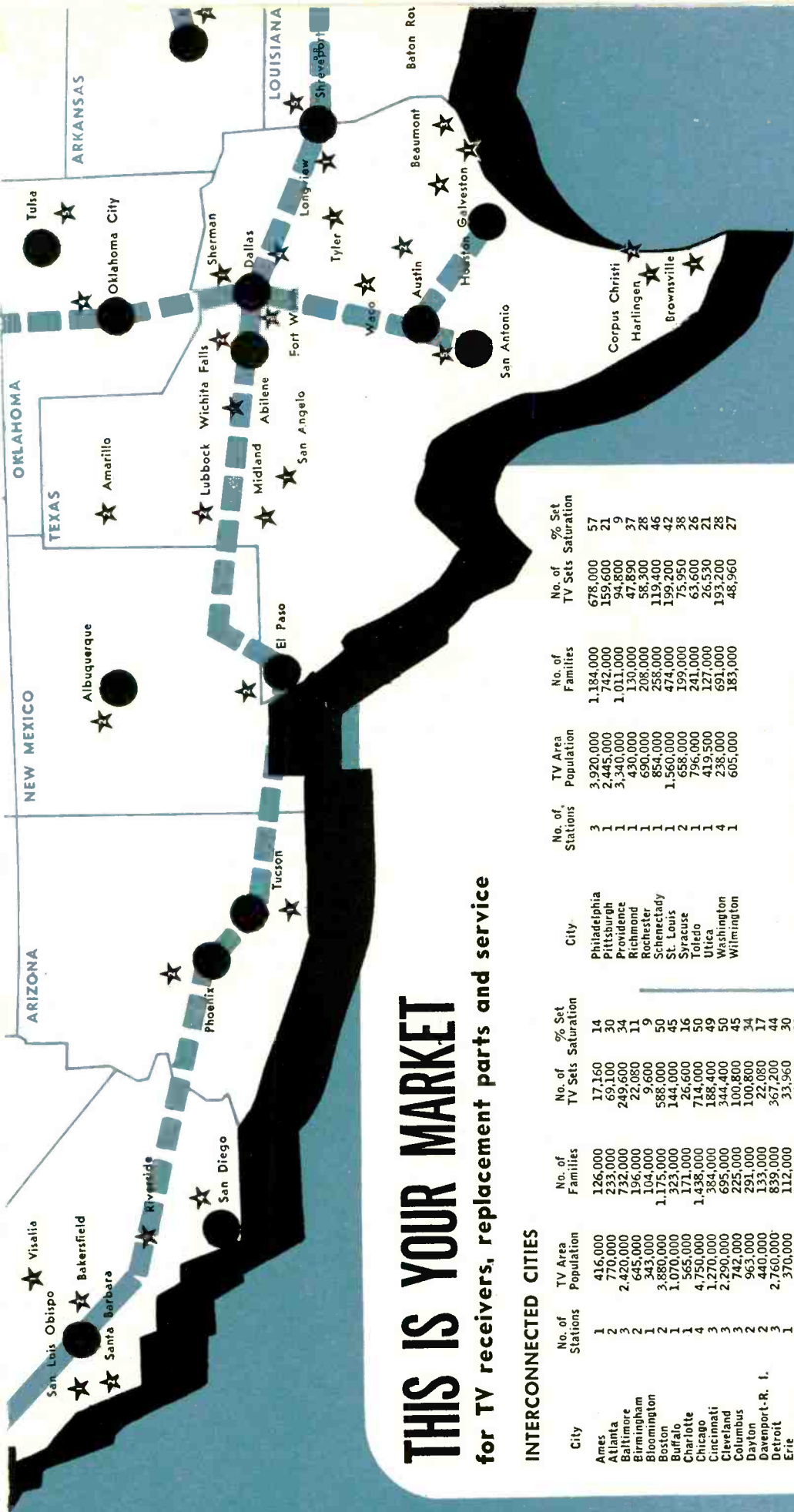

THIS IS YOUR MARKET

for TV receivers, replacement parts and service

INTERCONNECTED CITIES

City	No. of Stations	TV Area Population	No. of Families	No. of TV Sets	% Set Saturation	City	No. of Stations	TV Area Population	No. of Families	No. of TV Sets	% Set Saturation
Ames	1	416,000	126,000	17,160	14	Philadelphia	3	3,920,000	1,184,000	678,000	57
Atlanta	2	770,000	233,000	69,100	30	Pittsburgh	1	2,445,000	1,742,000	159,600	21
Baltimore	3	2,420,000	732,000	249,600	34	Providence	1	3,340,000	1,011,000	94,800	9
Birmingham	2	645,000	196,000	22,000	11	Richmond	1	430,000	130,000	47,890	37
Boston	1	343,000	104,000	9,600	9	Rochester	1	690,000	208,000	58,300	28
Buffalo	2	3,880,000	1,175,000	588,000	50	Schenectady	1	854,000	258,000	119,400	46
Charlotte	1	1,070,000	323,000	144,000	45	St. Louis	1	1,560,000	474,000	199,200	42
Chicago	4	5,655,000	1,711,000	266,000	16	Syracuse	2	1,658,000	519,000	211,000	38
Cincinnati	3	4,750,000	1,438,000	714,000	50	Tulsa	1	796,000	241,000	63,600	26
Cleveland	3	1,270,000	384,000	188,400	49	Utica	1	419,500	127,000	26,530	21
Columbus	3	2,290,000	695,000	344,400	50	Washington	1	238,000	691,000	193,200	28
Dayton	2	742,000	225,000	100,800	45	Wilmington	1	605,000	183,000	48,960	27
Davenport-R. I.	2	440,000	291,000	100,800	34						
Detroit	3	2,760,000	839,000	22,080	17						
Erie	1	370,000	112,000	33,960	30						
Grand Rapids	1	600,000	182,000	40,200	22						
Greensboro	1	545,000	165,000	23,400	14						
Huntington	1	435,000	132,000	24,150	18						
Indianapolis	1	930,000	281,000	75,900	27						
Jacksonville	1	310,000	94,000	18,000	17						
Johnstown	1	825,000	250,000	40,680	16						
Kalamazoo	1	473,000	143,000	17,160	12						
Kansas City	1	910,000	275,000	55,600	20						
Lancaster	1	280,000	85,000	70,650	83						
Lansing	1	550,000	168,000	22,800	14						
Louisville	2	621,000	188,000	55,800	30						
Memphis	1	586,000	177,000	59,150	33						
Milwaukee	1	1,078,000	327,000	175,200	54						
Minn.-St. Paul	2	1,100,000	333,000	145,200	44						
Nashville	1	508,000	154,000	2,400	2						
New Haven	1	1,840,000	557,000	114,600	21						
New York	1	11,850,000	3,597,000	1,867,000	52						
Norfolk	1	646,000	196,000	33,480	17						
Omaha	2	436,000	132,000	35,760	27						

NON-INTERCONNECTED CITIES

Albuquerque	1	72,600	22,000	5,520	25
Birmingham	1	435,000	131,000	22,800	17
Dallas	2	950,000	277,000	47,530	17
Ft. Worth	1	879,000	289,000	37,690	14
Houston	1	716,000	217,000	44,640	21
Los Angeles	7	4,540,000	1,372,000	765,500	56
Miami	1	386,000	117,000	40,680	35
New Orleans	1	744,000	225,000	41,160	23
Oklahoma City	1	456,000	138,000	50,780	15
Phoenix	1	162,000	49,000	20,930	43
Salt Lake City	1	307,000	93,000	30,360	33
San Antonio	2	430,000	130,000	30,240	23
San Diego	2	375,000	113,000	66,000	59
San Francisco	3	2,720,000	825,000	102,300	12
Seattle	1	1,030,000	307,000	45,350	15
Tulsa	1	414,000	125,000	41,170	33

All material prepared by, or under the specific direction of,
CONTI ADVERTISING AGENCY, NEW YORK, N. Y. • RIDGEWOOD, N. J.

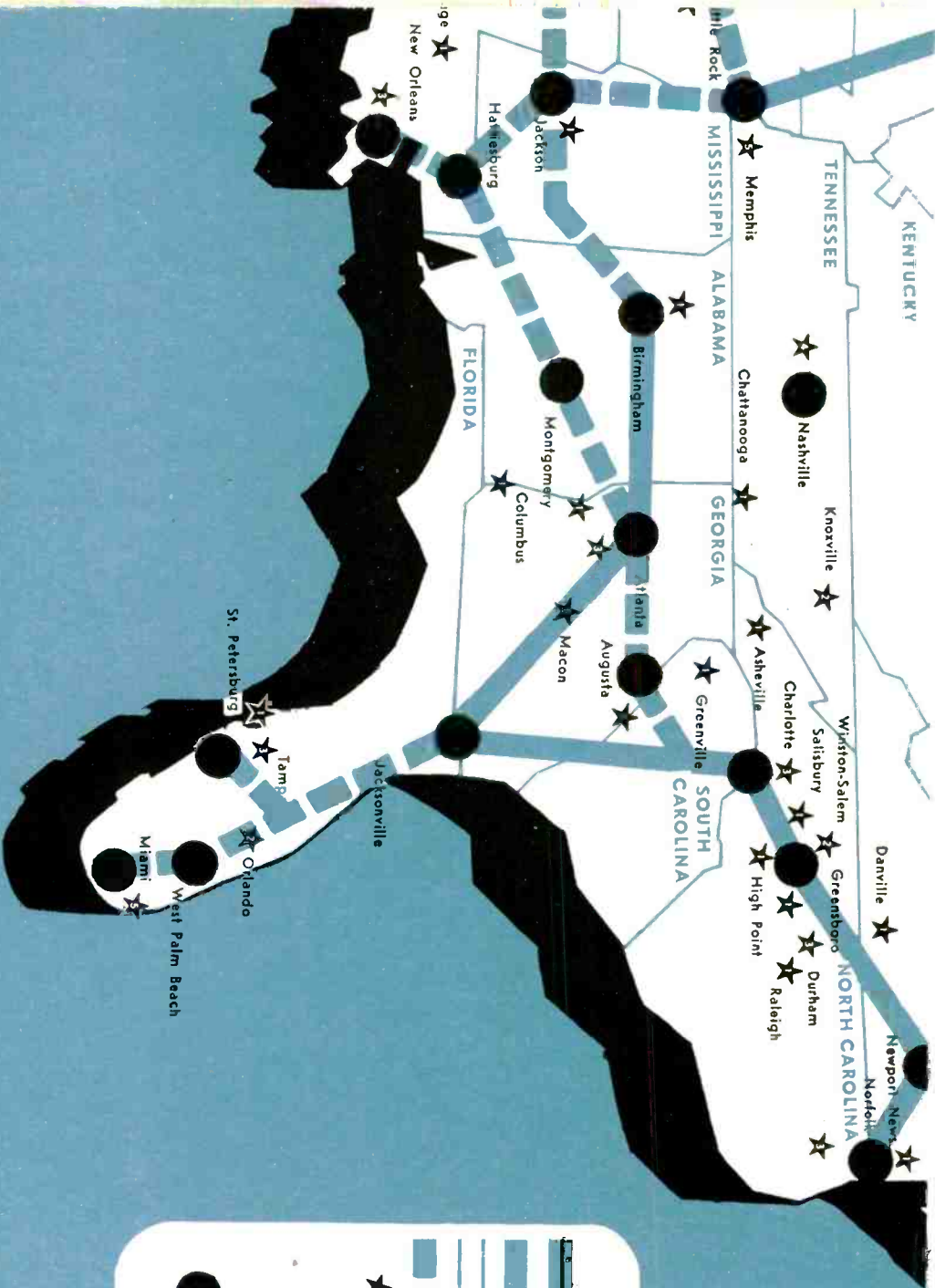

LEGEND

- Interconnected cities prior to 1950.
- - - Additional interconnections during 1950.
- · · Proposed interconnections (1951 and later)
- ★ City in which application(s) for TV station(s) is (are) now pending, the numeral within the star indicating the number of such applications.
- City in which TV station(s) is (are) now operating.

As market conditions dictate, it is our pleasure to compile and bring to you sound, factual material such as this in the interest of the stable development of the television industry, and the promotion of better business within that industry. We trust that you will find this information useful, and will be pleased to receive your comment.

Thomas Electronics, Inc.

Test Equipment for Servicers

JFD TV WAVE TRAP

Designed to filter out FM image and amateur harmonic interference, the "Clear-Beam" line of traps include 4 models for installation at antenna input terminals in parallel with the line. BR-106-10-30 covers 14-28 MC; BR-106-80-110

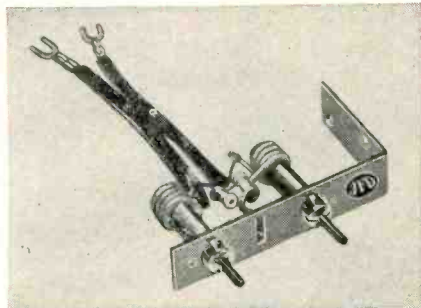

covers FM image interference; BR-106-30-60 covers 30-60 MC and BR-106-60-90 covers 60-90 MC. JFD Mfg. Co., Inc., 6101 Sixteenth Ave., Brooklyn 4, N. Y.—RADIO & TELEVISION RETAILING.

Freed MEGOHMETER

Model No. 1020 is an AC operated megohmmeter with electronically regulated high voltage supply, and is capable of measuring leakage resistance of insulating materials, condensers, cables, motors and windings. Range is 1 megohm to 2,000,000 megohms in 6 overlapping ranges. For more information on this and other laboratory-type test instruments, write for catalog to Freed Transformer Co., Inc., 1718 Weirfield St., Brooklyn 27, N. Y.—RADIO & TELEVISION RETAILING.

Duotone RECORDING TAPE

The makers of Duotone phonograph needles have announced production of a line of magnetic tapes in both plastic and kraft paper bases in 625 foot and 1250 foot lengths. The tapes are de-

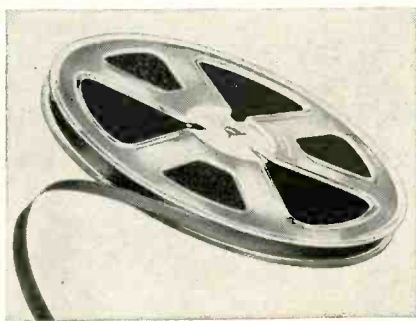

signed to afford high output with low noise, low friction and long life, and to be interchangeable with other good quality tapes. For further information write Duotone Co., Inc., Key Port, N. J.—RADIO & TELEVISION RETAILING.

Insuline CABINET

A new line of small utility cabinets with built-in, welded chassis are made of sturdy steel in black ripple finish and are available in six sizes ranging from 4 x 2 x 4 inches to 6 x 6 x 6 inches. They

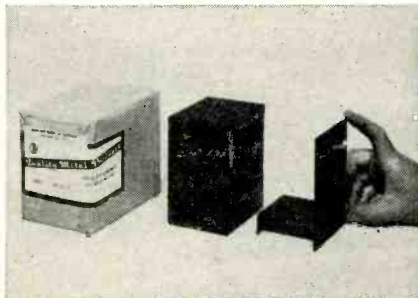

are suitable for minor radio-TV assemblies, control units, etc. Insuline Corp. of America, 3602 35th Ave., Long Island City, N. Y.—RADIO & TELEVISION RETAILING.

Service PARTS BINS

Two new bins were developed for stock rooms or sales departments to provide accessibility for small parts. The 700 bin is a wall unit with 100 compartments all tilted forward to meet the eye and with rounded bottoms to make parts easier to pick out. Each



compartment has a tag holder, and all compartments can be lifted from the rack for cleaning. The 320 bin is an island unit with compartments on both sides, providing 320 compartments. Service Parts Systems, 4607 St Aubin St., Detroit, Mich.—RADIO & TELEVISION RETAILING.

Prager PARTS RACK

Parts rack for resistors, condensers and other small parts may be hung on wall or placed on bench. Contains 64 two-inch envelope-type compartments enclosed in a wood frame. Price is \$4.35. Prager, 3515 So. Bronson Ave., Los Angeles 16, Calif.—RADIO & TELEVISION RETAILING.

Weller SOLDER GUN

Dual spotlights to eliminate shadows, and over/under terminals to brace tip and improve visibility are features of the new light-duty soldering gun WD-135. The new model is said to be con-



siderably smaller and lighter than previous 135 watt guns. Dual heat (100/135 watts) is provided, with 5-second heating time controlled by trigger switch. Weller Electric Corp., Easton, Pa.—RADIO & TELEVISION RETAILING.

Equipto DRAWER SEPARATOR

New type divider for parts bins and steel drawers has tilt-type top which improves visibility, provides label surface, and makes it easier to scoop small parts from the drawer. A free 24-page catalog is available, showing these and

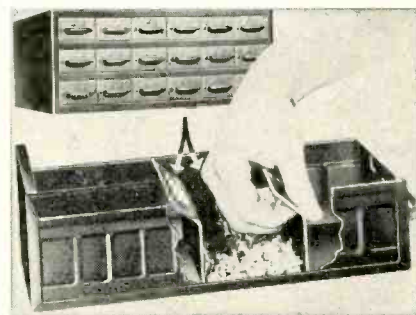

other Equipto equipment for shelving and storage of parts. Equipto Div. of Aurora Equipment Co., Aurora, Ill.—RADIO & TELEVISION RETAILING.

Ideal WIRE STRIPPER

Ideal Industries has purchased the Pyramid Products Co., also of Chicago. Best known of the Pyramid line is the "E-Z" wire stripper, which works like a pliers to remove insulation from wire. A feature of the "E-Z" Automatic model is a lever that automatically stops return of arms until wire is removed, eliminating crushing of wire. Available in 6 sizes for wire gauges ranging in sizes from #8 to #30. Ideal Industries, Inc., Sycamore, Ill.—RADIO & TELEVISION RETAILING.

New Sound & Service Units

RCA LOUDSPEAKER

The latest RCA speaker, the 515S2, is a 15-inch PM speaker featuring high sensitivity between 40 and 12,000 cps, with power handling capacity of 25 watts. A duo-cone arrangement provides a large cone driven by a 2-inch voice coil to produce low frequencies

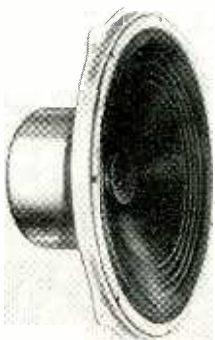

and a small cone driven by its own 3/4-inch voice coil to produce high frequencies. Each cone has its own air gap, and both air gaps are excited by a single Alnico V magnet. Wide directivity angle of 60 degrees is claimed. Due to the design of the cones, no electrical crossover network is needed. RCA Tube Dept., Harrison, N. J.—RADIO & TELEVISION RETAILING.

Bell AMPLIFIER

Model 2145 high fidelity amplifier features a remote control unit with a selector that not only permits switching to and from phono and radio (or TV) but also choosing correct equalization for different recording characteristics.

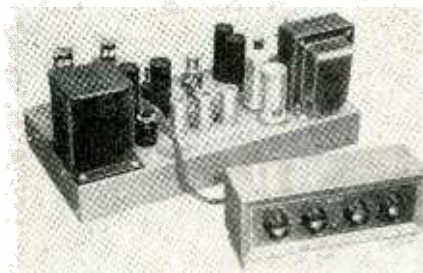

In addition there is a compensated volume control, a bass and a treble control. The amplifier is an all triode 30-watt (max) unit with response said to be plus or minus .25 db from 20 to 30,000 cps. 6 inputs are provided and it utilizes 12 tubes. Bell Sound Systems, Inc., 555 Marion Rd., Columbus 7, Ohio.—RADIO & TELEVISION RETAILING.

Snyder AUTO AERIAL

The "Hot Rod" police-type aerial for auto radios is a 4-section whip of chrome-plated brass with shock absorbing spring mount, red ceramic insulators, and red tenite static ball. Comes with 8 feet of UHF polyethylene cable and aircraft fittings. Snyder Mfg. Co., 22nd and Ontario Sts., Philadelphia 40, Penna.—RADIO & TELEVISION RETAILING.

Shure TAPE HEAD

Model TR5 tape head for magnetic tape recorders combines the functions of record, playback and erase in a single unit, and is said to have excellent frequency response and output level. Record and playback coil impedance is 1650 ohms at 1000 cps, while erase coil impedance is 1000 ohms at 40 KC. Output level is 5DB above 1 millivolt at 1000 cps at 3.75 in./sec. Shure Brothers, Inc., 225 W. Huron St., Chicago, Ill.—RADIO & TELEVISION RETAILING.

Astatic LP PHONO CARTRIDGE

Model CAC-J crystal phono cartridge is specially designed for optimum reproduction of slow speed records (33 & 45 RPM). Output is listed at .6 volt at



1000 cps on Columbia #103 test record and 1 volt on RCA 12-5-31-V test record. Another model, CAC-78-J with 3-mil needle for 78 RPM records is available. Both models use the Astatic type Q sapphire tipped needle. Asiatic Corp., Conneaut, Ohio.—RADIO & TELEVISION RETAILING.

Altec Lansing AMPLIFIERS

A new line of professional amplifiers, the 1400 series, has been designed for rack or console mounting. The series consists of the 1410A preamplifiers, the 35-watt A-1420A power amplifier, the 75-watt A-1430A power amplifier, the A-1440A line amplifier, the 1450A apparatus unit and the 30A power supply. The 1410A has two mixing input channels; the A-1420A can supply necessary power for 3 preamps; the 1430A will supply power for 6 preamps. The 30A power supply is used with the 1410A and the 1440A when they are not used in conjunction with a power amplifier. The 1450A is for use with the power amplifiers when they are not used in conjunction with the preamps. Altec Lansing Corp., 9356 Santa Monica Blvd., Beverly Hills, Calif.—RADIO & TELEVISION RETAILING.

N.J.R. AMPLIFIER

Especially designed to improve the audio channel on TV, the Model 10MT amplifier provides 6-8 watts output (push-pull) with response said to be 100-13,000 cps. Measuring only 3 x 5 inches, the unit can be fitted on, in or next to a TV chassis. Price is \$12.95. Manufactured by the N.J.R. Electronics Co., the amplifier is distributed by Milo Sound, 200 Greenwich St., N. Y. 7, N. Y.—RADIO & TELEVISION RETAILING.

Rauland-Borg AMPLIFIER

New unit in the "Green Gem" line is the model 1960 Bi-Power model, with rated output of 60 watts, response plus or minus 1 db 40-15,000 cps. Inputs include 4 mike and 2 phono, the latter



with dual fader. Mixing and fading on all 6 inputs is provided. Output impedances are 4,8,80 (70 volts), 250 and 500 ohms. Complement is 13 tubes including rectifiers, case is all metal. Rauland-Borg Corp., 3523 Addison St., Chicago 18, Ill.—RADIO & TELEVISION RETAILING.

Simpson PANEL METER

The firm is now making a line of modernistic panel instruments in 4 1/2, 3 1/2 and 2 1/2 inch sizes. The model numbers are 1029, 1027 and 1127. Large, easy-to-read scales are designed to provide greater readability under all light

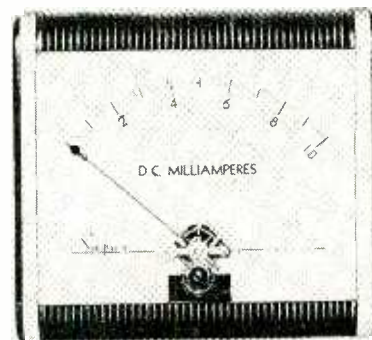

conditions. Etched faces extend across the entire fronts of the meters and are protected with unbreakable plastic. The rectangular instruments are said to be appropriate in outline for use with either modern or conventional equipment. Simpson Electric Co., 5200 W. Kinzie St., Chicago, Ill.—RADIO & TELEVISION RETAILING.

Terado DC-AC CONVERTER

"Trav-Electric" is a small-sized converter for use in boats, cars and planes for converting to 110 V. 60 cycle AC. Senior model 1160 is available for operation from 6 or 12 volts at up to 40 watts and lists for \$14.95. Junior model operates on 6 or 12 volts and either 110 or 220 VAC output, lists for \$11.95. Input plugs into cigar lighter; available also with battery clips. The Terado Co., St. Paul 8, Minn.—RADIO & TELEVISION RETAILING.

Selling *TELE-ROTORS* For You

On Television With A National Spot Program

In The Major Markets

4 Models to Fit *EVERY NEED* So You Can Sell the Right *TELE-ROTOR* for the Right Application

C-D and RADIART *TELE-ROTOR*

Tested and proven to be the outstanding rotator in the field... this heavy-duty TELE-ROTOR has no equal! Powerful... rugged... it will hold and turn any antenna array under any weather conditions! Easily and quickly installed—guaranteed for trouble-free performance!

MODEL TR-1... Rotator and control cabinet with end of rotation light (uses 4 wire cable)
..... **\$39.95**

MODEL TR-2... Rotator with "Compass Control" cabinet having illuminated "perfect pattern" dial..... (uses 8 wire cable)
..... **\$44.95**

ATX-8 8 wire cable..... 10c per ft.

C-D and RADIART *TELE-ROTOR CUB*

Here is the standard TELE-ROTOR... for all average installations. It features the ALL IN LINE design... and is powered by the same husky motor that has proven itself in the heavy-duty models.

MODEL 501-A... Rotator with control cabinet and flashing light indicating when rotator turns... (uses 5 wire cable)
..... **\$34.95**

MODEL 502-A... Rotator with control cabinet having indicating meter for "hair-line" tuning..... (uses 5 wire cable)
..... **\$44.95**

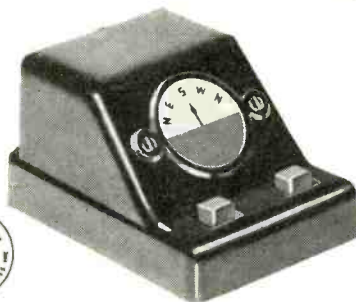

CORNELL-DUBILIER SOUTH PLAINFIELD, N. J.

THE RADIART CORPORATION CLEVELAND 2, OHIO

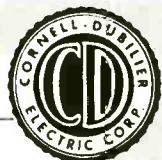

SERVICE & SOUND

Section of **RADIO & TELEVISION RETAILING**

Finding New PA Customers

*The Sound Business Is as Good as You Make It**

• A lot of important guys with charts, curves and colored pencils have shown that if you sold only an additional 10% of the available prospects for sound, your profits in sound would increase 100%!

How do you get this extra business? By finding out where the need for sound exists and creating a demand for its ownership.

New businesses or industrial enterprises are born every month in every city or town. Their number may vary from one to a hundred or more every 30 days. Their size and importance will range from a drive-in restaurant to a huge factory—each one a prospect for sound equipment from 1 to 500 watts. In addition, many already established firms are overlooking the convenience, the utility and the time and money saving possibilities of a sound installation and need to be shown how it can help them.

Drive-In Restaurants

Did you ever roll up to a drive-in, ravenously hungry, and then wait 15 or 20 minutes for a car-hop to take your order? A simple 1-watt intercom, coupled to a number of weatherproof speakers conveniently located near every car parking area, would eliminate this petty annoyance by providing two-way communication. Press a button, tell the restaurant what you want to eat and be served in a jiffy. In these days of streamlined selling, service pays off and is almost as important as food.

Super-Markets

Intercoms between the cashier and every department can do much to build up customer good-will as well as saving countless time-consuming trips between departments. A record player

* From ideas originated by the Sales Dept. of University Loudspeakers, Inc., 80 S. Kensico Ave., White Plains, N. Y.

and amplifier providing music in the store is another use of sound that pays off. It has been found that intervals of music make for more profitable selling (for the store) and enjoyable waiting (for the customer at the checkout counter). In addition, there are companies which sell tape recorded program equipment to chain groceries which make it possible to integrate music with spot announcements highlighting certain commodities.

Factories

Take a small portable amplifier with built-in record player, a few speakers and a microphone, and show the factory owner how you can save him valuable time in reaching personnel. Prove to him how he can build up employee morale and increase production by broadcasting music during periods of mental and physical fatigue. And how about the loading platform and shipping and receiving departments? They're the arteries of a well managed organization and should be within reach of key personnel at a moment's notice. This means paging speakers.

Garages

Garages are a natural for a combined paging and intercom system. The

countless trips between the service department and the office can be eliminated by pressing a button. Noise level is relatively low and you will be amazed at the area that a simple 50L6 output intercom will cover.

Churches

Don't overlook the church. More and more churches are passing up antiquated bell systems for modern electronic systems which are not only more efficient and flexible, but represent a fraction of the cost. Electronic systems can be sold for less than 2 to 3% of the cost of bells or chimes and the church can be assured of incomparable quality of tone, virtually no maintenance costs and increased sound radiation.

Laundries

As with factories, laundries have found that increased production as well as improved quality of product result from a plant music system. Why not take a crack at the laundries in your town with an FM-AM tuner, automatic changer, amplifier and a few speakers?

Tourist Camps

Many of these outfits are installing 3 to 5 channel systems, providing a variety of entertainment to their customers. A microphone input enables the camp owner to reach any cabin instantly, and where the camp incorporates a restaurant, it can be used to announce the various meals.

The latter feature has already proven a must for many of the large city hotels.

Self-Service Laundries

Estimates have shown that there are 1600 laundryettes serving 2,000,000 American families. The owner who can make his customer's wait more

(Continued on page 84)

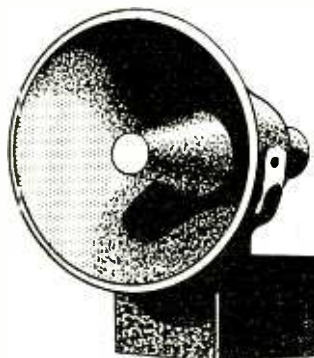

A vast potential for PA business is still to be sold by aggressive sound dealers. Get your share.

New Circuits and Circuit

Production Changes and Service Notes from Manufacturers Save

• WESTINGHOUSE models H-627-K16, H-628K16 and H-629K16: Service notes on these models supersede the H-627K16 and H-628K16 notes which bear form No. RM3187.

For service information on these models, refer to the H-626T16 and H-630T14 service notes and any supplementary information thereto. The V-2171 chassis assembly is basically the same as the V-2172 and V-2176 chassis assemblies which are covered by the H-626T16 and H-630T14 service notes. (See accompanying schematic.) There are differences, however, and these differences are as follows:

1. The cathode ray tube is type 16JP-4A in the V-2171 chassis.

2. The resistor (R414) that is connected between pin #6 of the vertical multivibrator and the height control is 560,000 ohms in the V-2171 chassis.

3. The capacitor (C430) that is connected between terminal #4 of the horizontal output transformer (T402) and ground is .06 mfd in V-2171 chassis.

4. The capacitor (C432) that is connected between pin #3 of the 6W4-GT damper tube and ground is 0.1 mfd in the V-2171 chassis.

5. The decoupling resistor (R424) in the plate supply circuit for the vertical output tube is 470 ohms rather than 5000 ohms, and it returns to the junction of C416 and the horizontal deflection coil (Z402) rather than to terminal #4 of the horizontal output transformer (T402). In some chassis used in early production of Models H-627K16 and H-628K16, R424 is connected directly to the 325 volt B plus line. *If centering difficulty is experienced with these early chassis, R424 should be changed as described above.*

6. A 5600 ohm resistor (R456) is added in parallel with the horizontal linearity control (L402). Some early chassis used in Models H-27K16 and H-628K16 do not contain R456. *The resistor is added in later production to eliminate vertical shaded lines on the raster by suppressing "ringing" in the control.*

7. The reactor (L403) in the filament circuit of the IX2A high voltage rectifier is omitted in later production. *In early production chassis which contain L403, "blooming" caused by low filament voltage at the IX2A may be eliminated by removing the reactor.*

8. The resistor (R446) that is connected between pin #1 of the horizontal multivibrator and the ringing coil is 18,000 ohms. In some early produc-

tion chassis used in Models H-627K16 and H-628K16, R446 is 15,000 ohms. *Better stability of the horizontal multivibrator may be obtained in these early chassis by changing the resistor to 18,000 ohms.*

9. The 5000 ohm resistor (R213) in the 6AQ5 audio output circuit is connected from the output of the low voltage power supply filter to the junction of R212 and C212 in the 6AQ5 cathode circuit. *In some early chassis where R213 is not connected in this manner, the power dissipation in R217 can be reduced by changing the connections.*

10. A .005 mfd capacitor (C222) is added between the high side of the volume control and the junction of C207 and R204. *In some early H-627K16 and H-628K16 chassis that do not include C222, the tendency for the volume control to become noisy can be eliminated by adding the capacitor.*

11. The 4.7 mmf capacitor (C309) connected between pin #7 of the 6AL5 video detector and ground is not used in the V-2171 chassis.

12. The value of the sound take-off capacitor (C201) is 4.7 mmf, and it is connected between pin #1 of the 6AU6 1st sound I-F amplifier and pin #7 of the 6AL5 video detector.

13. A 120 mmf capacitor (C223) is added in parallel with L201 in the grid circuit of the 6AU6 1st sound I-F amplifier.

Insufficient Pix Width

14. In some V-2171 chassis, a 1.8 microhenry reactor (L406) in parallel with a 5600 ohm resistor (R454) is inserted in the line that runs between the horizontal winding of the deflection yoke and C416. *If sufficient picture width cannot be obtained in these chassis, the reactor and resistor should be removed from the circuit.*

15. *In later production chassis, several changes are incorporated to stabilize the horizontal multivibrator operation.* The resistor (R436) in the pin #6 plate circuit of the horizontal multivibrator is changed to 270,000 ohms, a 220,000 ohm resistor (R457) is inserted in parallel with R434 in the pin #7 grid circuit, and a 120 mmf capacitor (C442) is inserted in parallel with C422 between pins #1 and #7. In some V-2171 chassis that use a 12BH7 tube as the horizontal multivibrator and do not contain the above changes, a 1.5 mmf capacitor (C441) is connected between pins #6 and #7 to improve the multivibrator performance. The effect of C441 is negligible,

however, when the above changes are made.

RCA Victor Models

• RCA Models 6T54, 6T64, 6T65, 6T71, 6T74, 6T75, 6T76: RF unit tube changes—Since most of the circuits are low capacitance circuits, the RF unit may require readjustment when the tubes are changed. If the 6CB6 RF amplifier tube is changed, it may be necessary to readjust C16 and C22 (both on top of the RF unit). If the 6J6 oscillator and mixer tube is changed, more extensive adjustments are required. Variations in interelectrode capacitances of different tubes affect tracking of the mixer grid circuit and may necessitate realignment. It may be possible, however, to try several 6J6 tubes and select one which gives satisfactory performance without realignment.

Admiral Corp.

• ADMIRAL models using 24D1, 24E1, 24F1, 24G1, 24H1 and 5B2, 5D2 Chassis:

The circuit design of the 24D1, 24E1, 24F1, 24G1, 24H1 chassis is very similar to the 21A1 chassis.

The 2nd anode voltage in the 24D1, 24E1, 24F1, 24G1 and 24H1 chassis is approximately 13 KV. This increased voltage, developed by a new high-efficiency horizontal output transformer and horizontal output tube (6CD6G), gives a brighter picture. No voltage doubler circuit is required. A new vertical output tube (6S4) is used. This miniature triode will operate under higher plate voltages. An auto-transformer (vertical output) is used in the plate circuit.

Television chassis 24D1, 24E1, 24F1, 24G1 are electrically identical. The 24H1 chassis, is electrically the same as these except for values of R408, R442, and C437. These value differences result from the need for different sweep requirements for the rectangular tube. These chassis also have minor differences such as ion trap, picture tube mounting, and mechanical parts.

Run 2 in 24H1

R322 decreased in value to increase brightness control range. Picture tube brightness range was increased by changing resistor R322 from 100,000 ohms, ½ watt to 33,000 ohms, ½ watt (part number 60B8-333). With this change, the Brightness control will completely cut off the picture tube beam current when the Picture control is advanced all the way.

Run 3 in 24D1, 24E1, 24F1, 24G1

Changes for Latest TV Sets

Troubleshooting Time and Improve Performance

Current limiting resistor (R328) deleted to improve focus. Due to variations in tube characteristics of short-neck picture tubes, it was necessary to add R328 (22,000 ohms, 2 watt) to some receivers produced before Run 3. Other receivers did not have this resistor. In a few sets, a compromise resistor of 15,000 ohms

was used.

If difficulty in focus is encountered in any chassis (either earlier or later than Run 3), determine if resistor R328 is necessary by checking as follows:

a. Picture will focus only with focus control all the way to the right (clockwise). Add R-328 (22,000

ohms, 5 watt, part number 60B20-223).

b. Picture will focus with focus control all the way to the left (counterclockwise). Remove R328.

If adding or removing R328 does not help, try changing the 6V6GT audio output tube (V205).

(Continued on page 100)

Schematic for Westinghouse models H626T16 and H-630T14 using chassis V-2172 and V-2176. Changes from this schematic as found in chassis V-2171 (models H-627-K16, H-628-K16 and H-629-K16) are explained in the text.

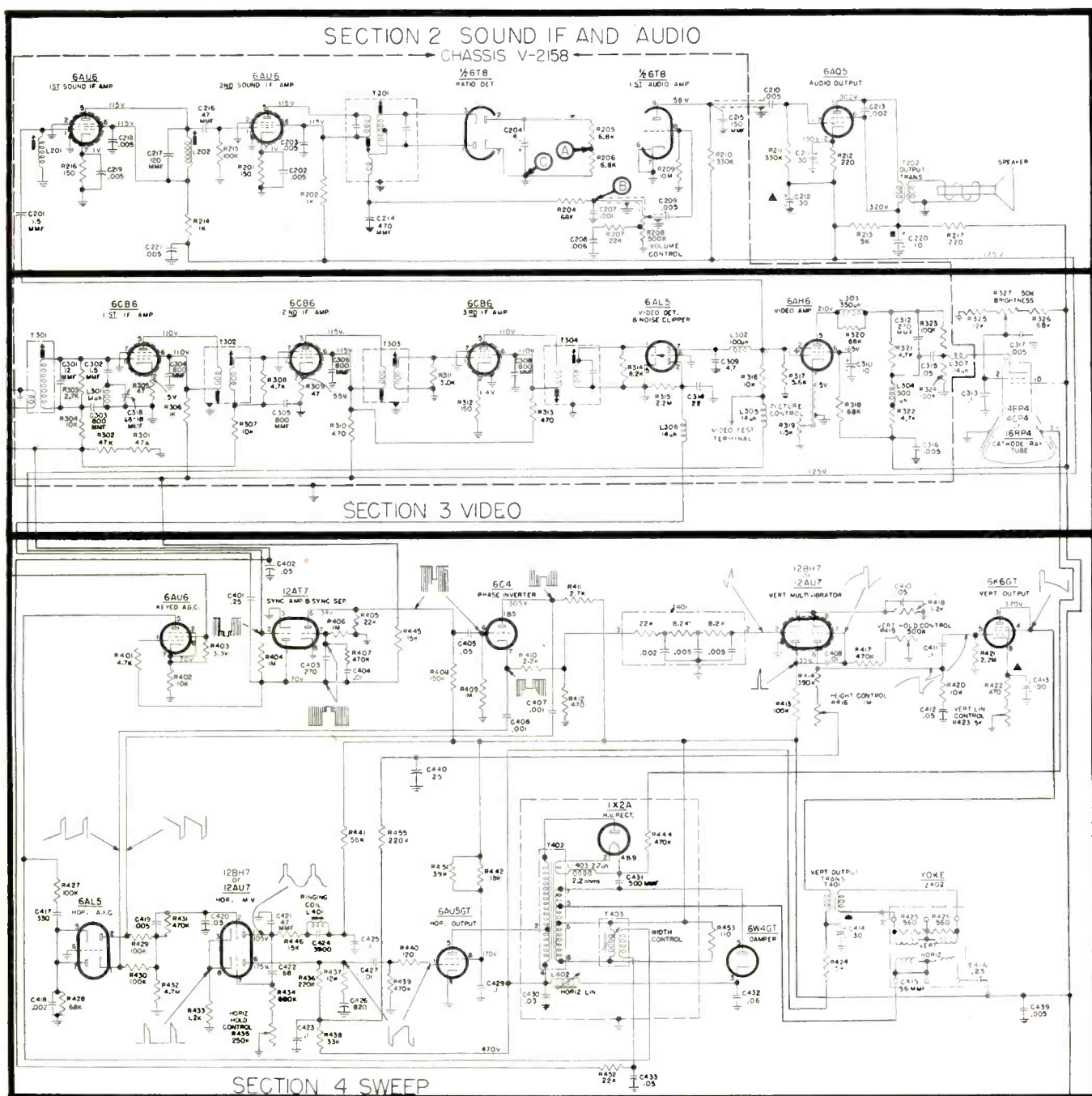

Crystal Diodes Replace

Use of Germanium Units Found Increasing in 1951 Models; Simplification of

• First used in military electronic equipment during World War II, germanium crystal diodes have recently been proving their worth in consumer products, particularly television sets. They are now available for replacement purposes, as well as in original equipment.

Briefly, these units are basically the same as the crystals we knew in early crystal receivers: that is, they are rectifiers. It is mainly the characteristics and constructional features of the new crystals which make them different from early crystals. The latter usually used crystals of the mineral Galena; a "cats whisker" or fine wire was used to find a "hot spot" on the crystal; and the characteristic of the unit was that it conducted better in one direction than the other. The 1N23's that were used in radar employed crystals of silicon, and the units that are being used now in TV (1N34, etc.) utilize crystals of germanium.

Many Advantages Seen

One characteristic of the silicon and germanium crystal diodes is that it isn't necessary to search for a hot spot with the catswhisker, and therefore the latter can be permanently fixed. This means that the crystal diode can be sealed up in a cartridge, which greatly increased its utility. Other characteristics of these diodes are: Relatively flat response at Very High Frequencies over a relatively wide dynamic range of signal levels; low forward resistance, which contributes to good rectification efficiency at low signal levels; transit time, interelectrode capacitance and internal noise, which are limiting factors in the use of vacuum tubes at VHF and UHF, are relatively negligible in the germanium diodes; and finally, of course, when compared with a tube, the germanium diode with pigtails can be soldered in like a resistor—takes little space, needs no filament wiring or other voltages, and no tube socket.

Reverse Current Passed

On the negative side, it should be mentioned that germanium crystal diodes will not withstand as high inverse voltages nor as high ambient temperatures as will equivalent vacuum tubes, such as the 6AL5. Also, it is well to note that while the back resistance is much higher than the forward resistance (the ratio is about 100:1 for germaniums) it is nevertheless a finite resistance (roughly about

100,000 ohms), and current will flow in the inverse direction. A vacuum tube diode, on the other hand, would pass no current if its anode were made negative.

However,—and this should really have been listed under the advantages—the life of a germanium diode (estimated at 10,000 hours) greatly exceeds that of a vacuum tube when operated properly, observing the peak inverse voltage and operating temperature. Table 1 shows some of the pertinent features of the more popular types of germanium crystal diodes used in TV receivers.

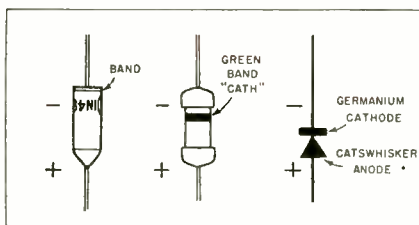

Fig. 3: Proper polarity indications for germanium diodes.

For circuit connection purposes, the characteristics of the crystal diodes are shown in figure 3. Considering the interior of the crystal, the catswhisker is comparable to the anode of a rectifier and the germanium crystal is the

cathode. As would be expected, the plate is considered to be the positive end and the cathode the negative. As in a tube rectifier circuit, however, the output is taken from the cathode. This

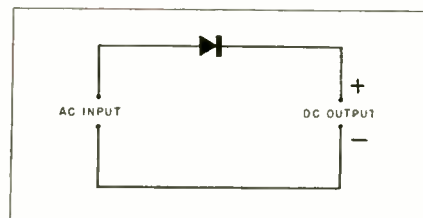

Fig. 4: Output taken from cathode (minus) end of diode.

is shown in the simplified schematic of figure 4. On the Sylvania (1N34, 1N60) crystals, the cathode end is marked with a green band. On the General Electric (1N64, 1N65) crystals, the cathode end is the larger end (opposite to the tapered end). Earlier Sylvania diodes had a "plus" and "minus" sign instead of the green band. The newer GE crystals also have a band on the cathode end. The "minus" end corresponds to the cathode end and should be placed in the circuit so that it faces the "plus DC" output end of the circuit. This is important due to the relatively low inverse rating of the units and the fact

Table 1

	1N34	1N60	1N64	1N65	6AL5
Peak Inverse Volts	75	70	20	85	330
Inverse current @ -50V	.8ma	(not known)		.2ma	0
Ambient Temp. Range*—50° to + 75°C for all types —					
* Fahrenheit = 9/5 (C + 32)					

Table II

Current TV models using a germanium crystal diode as video detector

Make	Models	Crystal
Andrea	Normandy	1N34
Arvin	2121TM, 2123TM, 2120CM, 2126CM, 2124CCM, 3080T, 2161TM, 2160CM, 2164CM, 2162CCM	1N64
Brunswick	616, 6161, 1116	1N34
Emerson	673, 660, 665, 664	1N60
Freed	54, 55, 56, 68, 101, 103, 104	1N64
GE	All current models	1N64
Hallicrafters	805, 806, 809, 810	1N60
Hoffman	All current models	1N60
I.T.I.	248, 348	1N34
Magnavox	Cosmopolitan	1N36
	French Provincial	1N60
Majestic	All current models	1N64
Mercury	6111, 6114, 9114	1N34
North Amer. Philips	1200, 588	1N34
Pilot	127, 163, 166	1N60
Setchell-Carlson	150, 1500, 1500LP	1N34
SMA Co.	111, 114, 117	1N34
Stewart-Warner	9200A	1N64
Tele-Tone	All except Imperial models	1N64
Trad	All current models	1N34
Zenith	All current models	1N64

Tubes in New TV Sets

Manufacture and Servicing as Well as Improved Performance Noted

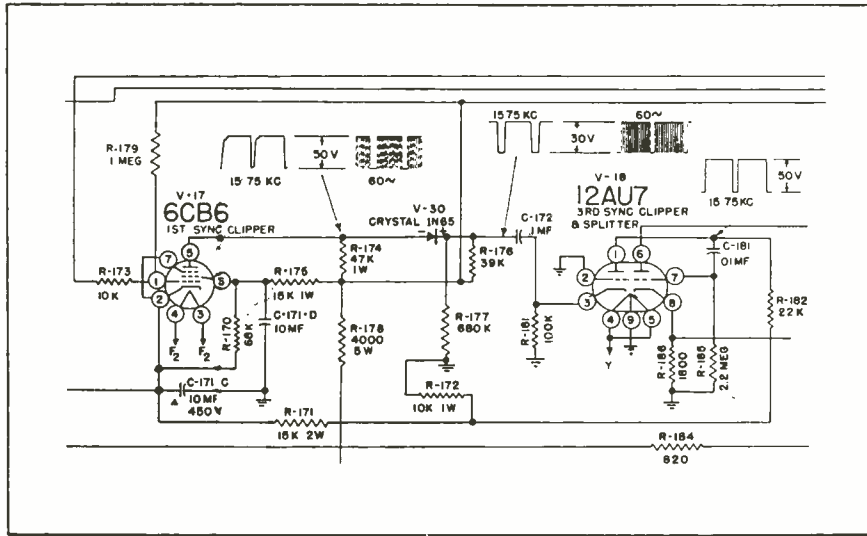

Many Other Types and Uses for Germaniums

The use of germanium crystal diodes in a wide variety of equipment [close to 3 million will have been sold by the end of this year] can be considered still in its infancy; and the use of these units in home TV receivers, covered in this article, represents but one of the many growing markets for them. At present approximately half a dozen out of more than 35 available types are being employed in TV sets. In addition to this use, many are finding their way into radios (particularly FM), test and measuring equipment, commercial and government communications equipment, research equipment, etc., and new uses for them are being uncovered daily.

that they will pass current in the wrong direction.

Several Uses In TV Sets

The most common use for germanium crystal diodes in TV sets to date is as the video detector. 23% of the models listed in RADIO & TELEVISION RETAILING'S TV Set Specifications (September 1950 issue) use a crystal in this function. A list of these models is shown in Table II.

A typical video detector circuit using a germanium crystal diode is shown in figure 5. The receiver is General Electric 16T3, 16T4, 16C113 and 16C116.

Still another application of the germanium crystal is shown in figure 6, in which is shown a portion of the schematic of the Stromberg Carlson 119 series receivers (Empire, Georgian, 18th Century and Chinese Classic). V-30, a 1N65, is used as the 2nd Sync Clipper. This operates in conjunction with V-17 (1st Sync Clipper) and V-18 (3rd Sync Clipper and Splitter) to remove large noise pulses, to maintain the proper blanking level and to separate the sync signals from the video.

Used For DC Restorer

Germanium diodes may also be used for DC restorers. Substitution of a 1N65 for a 6AL5 DC restorer in the GE models 12T3 and 12T4 is shown in figure 7. Many of the late model sets, however, eliminate the necessity for DC reinsertion by using direct coupling from the video amplifier to the

(Continued on page 102)

Fig. 5 (at right) a portion of the schematic for GE TV sets 16T3, 16T4, 16C113 and 16C116. The symbol beside the diode is the physical appearance of the unit as shown in fig. 3. Fig. 6 (Above) Stromberg Carlson 119 series. Due to an error in the original diagram, the symbol for V-30, the 1N65, should be reversed from that shown, so that the bar designation (the cathode) connects to the plate circuit of V-17. Receivers are wired correctly in this respect. Fig. 7 (below) GE model 12T3, showing how a crystal diode can be substituted for V2, 6AL5, the DC restorer.

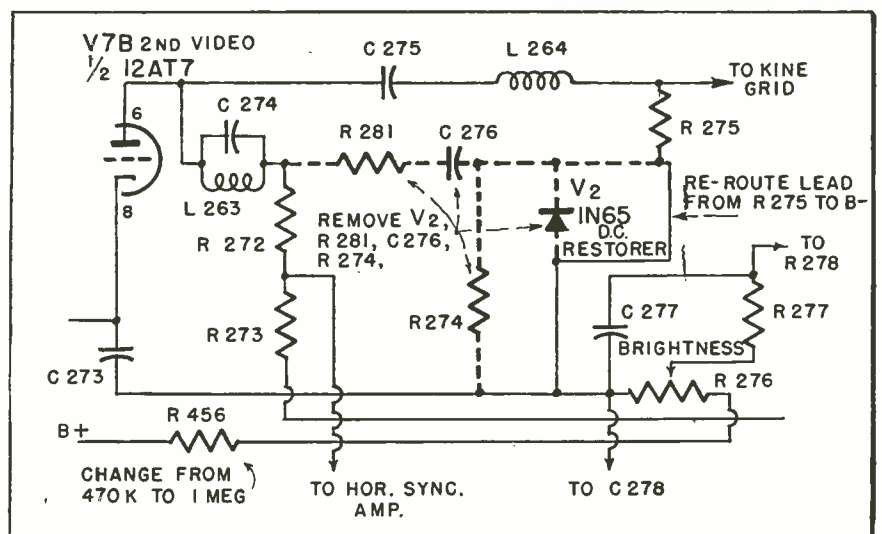
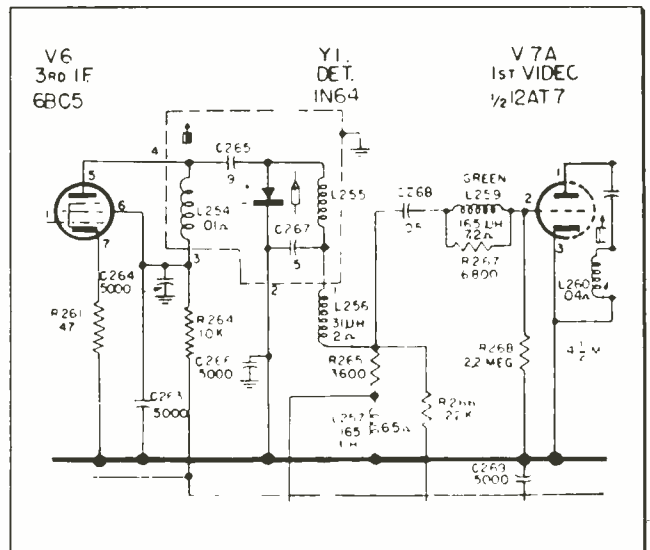

Color TV Questions & Answers

What the Serviceman Will Want to Know to Keep Abreast

of the Situation, and to Answer His Customers' Queries

(For a general analysis of the new color TV, see the article "CBS Color TV" in the October, 1950 issue Radio & Television Retailing.)

• 1. **What is the latest on color TV?** On October 11, 1950 the FCC issued a final decision selecting the field sequential color TV system developed and demonstrated by CBS as the authorized system for future color broadcasting. This decision becomes effective November 20.

2. **Will color broadcasting start immediately?** CBS has announced that as soon as the decision is effective they will commence broadcasting some programs in color from their New York station, WCBS-TV (channel 2). They have said that about 20 hours per week will be broadcast (about 3 hours a day). The hours were not specified, but it is expected to be during hours not now used for TV broadcasting (early morning, late at night). No existing programs are expected to be broadcast, but rather new material, probably not sponsored. It has been stated that some of these programs will be made available to the CBS-TV network. No other broadcaster has equipment to send out color TV, and none has yet announced plans to do so.

3. **Will existing sets be able to receive color programs in black and white?** No. The scanning frequencies are different, and out of the range of the hold controls of practically all existing sets. Therefore the picture will not sync. At best, the set will hold sync on 4 or 6 pictures simultaneously, and will look like a sheet of postage stamps.

4. **What are the new scanning frequencies?** The standards for CBS field sequential color are as follows: 24 frames (as opposed to the present 30), 144 fields (2 for each of the three primary colors, or 6, times 24 frames: $6 \times 24 = 144$), and 405 lines (as opposed to present 525, representing some loss of definition). The horizontal scanning rate, which is 15,750 cps in present sets, will be 29,160 (405 lines times 24 frames times 3 complete color pictures, one for each primary color; $405 \times 24 \times 3 = 29,160$).

5. **Is the bandwidth the same as present monochrome TV?** Yes, 6 MC.

6. **Is the sound still the same as present monochrome TV?** Yes, still FM.



10-inch TV set with removable 22½-inch color converter. See text for explanation.

7. **If I change the scanning frequencies of a present monochrome TV set to the proper values, will I get pictures in color?** No. If you do the job properly, you will get the set to sync up on a single frame picture, and you will then see in black and white what is being broadcast in color. However, it is not advisable to do this until you find out from the set manufacturers what will be the effect on the deflection and high voltages systems. Remember, you will be almost doubling the horizontal rate, and almost tripling the present field frequency (which is 60 cps).

8. **What does "Adaptation" and "Adapter" mean with respect to color TV?** Adaptation is the process of correcting the scanning rates so as to receive the color program in black and white. Because adaptation is necessary, the CBS color system is said to be "incompatible." The word adapter is used loosely; so far there has been no separate gimmick or box produced which will effect adaptation. "Adapter" or "Adaptation" can be presumed to mean the same thing, namely circuit changes in the set.

9. **What will be necessary, in addition to adaptation, to see color?** A color disc revolving in front of the picture, in step with one revolving in front of the camera tube. This will be constructed of transparent plastic, with segments of the three primary colors (red, blue, green) in a certain configuration, and of a certain size (22½" for 10-inch tube, 26" for 12½-

inch tube). An engineering drawing of such a disc will be reproduced in these pages next month. The disc will be driven by a small synchronous motor. A lens of some sort may be provided for the three-color picture to be framed. A magnifying lens is usually used for this purpose since it also enlarges the picture. The complete unit is shown in the accompanying photo, where the color disc (enclosed in a drum), the magnifier and the motor are enclosed in a single unit which can be moved in front of the picture or away from it. The set shown is a 10-inch set. Due to the size of the color disc unit, it is felt to be physically impractical to so convert sets with larger than 12½-inch tubes unless the picture size is reduced. It should be pointed out, also, that the use of such a converter would present difficulties on a console cabinet, especially one with doors.

10. **Who will make the adaptation?** The service dealer or dealer with a service department will do this work. Manufacturers will not be able to handle it. The work will be C.O.D. (not included in the cost of the set or the warranty) and the cost will be determined by the servicer according to the labor and parts he must expend, plus any warranty he wishes to provide. An adapted set would, at the flip of a switch, be able to receive either present monochrome (525 line, 30 frame) pictures or CBS-type color

(Continued on page 82)

More light on the
radio tube situation . . .



AN OPEN LETTER TO RADIO SERVICE DEALERS

SYLVANIA ELECTRIC PRODUCTS INC.

EMPORIUM • PENNSYLVANIA

First of all, we want to thank all of you good service dealer friends for your loyalty and cooperation.

Here are the FACTS: Even before the Korean trouble, the increasing demand for Sylvania Tubes was keeping our factories on round-the-clock production schedules. With the meteoric growth of television, still greater production facilities were needed.

Since the Korean war a flurry of buying by industrial customers and the service industry alike soon reduced warehouse and factory stocks to an all-time low.

Here's how Sylvania protects You now: To make certain that all of its regular service dealer customers are protected in this period of limited supply, Sylvania has effected a three-fold program of protection.

1. Production facilities have been greatly increased. Two additional plants have already been placed in operation. Another is under construction.
2. Your Sylvania radio and television tube suppliers are now being taken care of on an allocation plan, which we feel is established on the fairest possible basis.
3. Sylvania will continue to supply you with complete technical information for your service work, including latest data on substitution of available types for critical types.

Sylvania realizes that in the months ahead the whole country will depend upon you service dealers to keep its radios, TV sets and communications equipment in top working order. Your Sylvania Distributor will not have all the tubes you want but will do his best to serve you. We feel a deep obligation to give you the greatest possible aid in doing this job, but naturally, our country's defense needs come first.

As we have demonstrated in the past, Sylvania is ever mindful of the importance of its Service Dealers and servicemen to the nation and to the industry. We will continue to do everything possible to preserve the fine relationship existing between Sylvania, its distributors, and you, its loyal dealer customers.

Cordially yours,
SYLVANIA ELECTRIC PRODUCTS INC.

H. A. Rainer
Manager, Distributor Sales

INCANDESCENT LAMPS • RADIO TUBES • FLUORESCENT LAMPS AND FIXTURES • ELECTRONIC DEVICES

OVER
2,000,000

OVER

3,000,000

TUNERS.

Now in Use

OVER 75 TV SET MANUFACTURERS
USE "THE STANDARD TUNER"

Standard COIL PRODUCTS CO

Standard

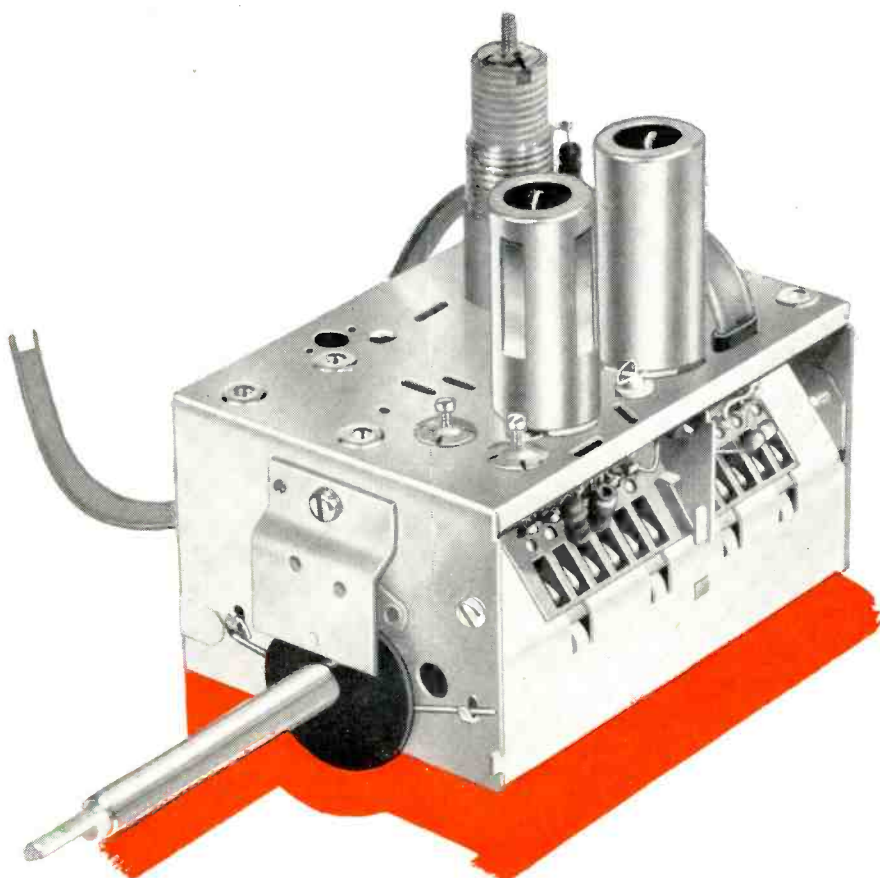

INC.

Chicago
Los Angeles
Bangor, Michigan

"THE STANDARD BOOSTER"
FOR FRINGE AREA RECEPTION

Beat the Tube Shortage!

This Sensational New RIDER Book Shows You HOW to Do It!

RECEIVING TUBE SUBSTITUTION GUIDE BOOK

by H. A. Middleton

For AM-FM-TV Receivers and Allied Equipment!

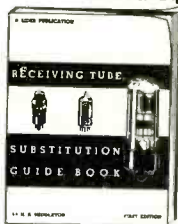

URGENT! Receiving tubes are very scarce and will get scarcer. There is a wide scramble for every type of tube, and you can't always get what you need. What can you do when you can't find a tube replacement? How can you get a set working again? How can you substitute one tube for another?

HERE!

HERE Are The Answers To All Tube Problems!

- 2500 Radio And TV Tube Substitutions Are Listed!
- TV Receiver Filament Wiring!
- Heater Substitution Wiring Instructions!
- Tube Types Classified By Functions!
- And A Wealth Of Other Priceless Data!

Here the serviceman will find 2500 radio and TV tube types systematically listed in numerical sequence with accompanying wiring instructions for making the substitutions. There are views of original and substitute tube sockets, and clear explanations for whatever changes may be necessary. In this, one of the most important servicing books ever published, and certainly a most timely one right now, the serviceman will find the way to turn out jobs that would otherwise remain on the shelf because of lack of proper tubes.

EXTRA! EXTRA! In addition to tube information... this sensational book contains material on Cathode-Ray Tube Characteristics, Complete Tube Characteristics Chart, Ballast Tube Data, Pilot Light Information, Resistors—Capacitors—Transformer Color Codes, Transformer Substitution, Fixed Condenser Substitution, and Converting Farm Radio for Electrified Operation.

208 Pages in Heavy Durable Paper Cover. 8 1/2 x 11 inches. Only **\$2.40**

10 DAY MONEY BACK GUARANTEE
Make this book **PROVE** its value!
Unless you agree that it is the best investment you've ever made—return it, and we will refund your money.

Rush This Coupon Today

JOHN F. RIDER PUBLISHER, INC.
480 Canal Street, New York 13, N.Y.

Please send me _____ copies of "RECEIVING TUBE SUBSTITUTION GUIDE BOOK" at \$2.40 per copy. I am enclosing check money-order in the amount of \$_____. If, within 10 days, I am not satisfied—I will return the book(s) in good condition, for refund.

Name _____

Address _____

City _____ Zone _____ State _____

7

New Merchandise

Scott "WENTWORTH"

A new 16-inch television console has been introduced. Known as the Wentworth, it is the first direct-view TV-only



set in the Scott line. Featuring a black rectangular tube, the set comes in a dark mahogany cabinet with full length doors. List price is \$385. Scott Radio Laboratories, Inc., 4541 North Ravenswood Ave., Chicago 40, Ill.—RADIO & TELEVISION RETAILING.

Philco 16-INCH TV

The model 1607, 16-inch table model TV set, is the most recent addition to the Philco line. In a metal cabinet, the set features a built-in, tunable aerial. Cabinet is finished in dark mahogany. List price is \$249.95. Philco Corp., Tioga & C Sts., Philadelphia, Pa.—RADIO & TELEVISION RETAILING.

Universal MIXABLEND

New Mixablend, two-speed, air-cooled, kitchen aid which blends, mixes, whips, purees, and grinds, has been announced. Designed to stand solidly,

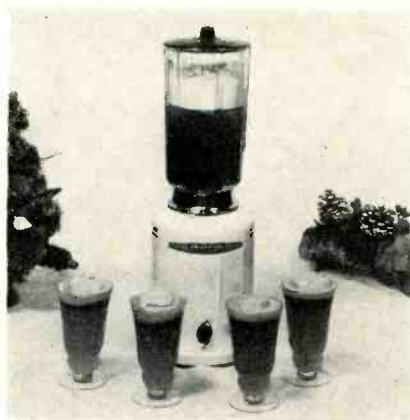

even when running at top speed. Blades are stainless steel. Glass container has 32 ounce capacity. Landers, Frary & Clark, New Britain, Conn.—RADIO & TELEVISION RETAILING.

Webster-Chicago PHONOGRAPH

A newly introduced portable three-speed manual phonograph is called the model 130 Fonograf. Plays all speeds and sizes, single needle. Case is bur-



gundy simulated leather. List price is \$39.95. Webster-Chicago Corp., 5610 W. Bloomingdale Ave., Chicago 39, Ill.—RADIO & TELEVISION RETAILING.

Merix ANTI-STATIC

A new anti-static liquid for all types of plastic records. May be used also on TV lenses, plastic furniture, etc., to keep dust-free. One 4 oz. bottle will treat several hundred records; priced at \$98. Merix Chemical Co., 1021 E. 55th St., Chicago 15, Ill.—RADIO & TELEVISION RETAILING.

Gale Dorothea TURNTABLE

A reversing midget turntable for use in window displays has been announced. 35 different back-and-forth arcs of travel may be had with the turntable. Stands 2 1/4" high, comes equipped with a 6" diameter hardboard disc.

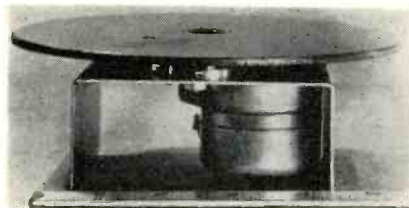

Drilled bracket permits floor, wall or ceiling mounting. Operates on AC only. Gale Dorothea Mechanisms, Jackson Heights, Long Island, New York.—RADIO & TELEVISION RETAILING.

Taco YAGI ANTENNA

A new 5-element yagi antenna is available for any one TV channel in either high or low band. Three directors, antenna element and reflector are designed for good performance in fringe areas. Antennas are pre-assembled for quick installation and are of all-aluminum construction. The yagis may be stacked. Technical Appliance Corp., Sherburne, N. Y.—RADIO & TELEVISION RETAILING.

Color TV

(Continued from page 80)

pictures (24 frame, 405 line) in black and white. The dealer would also sell the converter to those who wish one, enabling them to see color pictures in color.

11. What should I tell the customer who is thinking of buying a set now, but who is afraid that color will make it obsolete? You can tell him that his investment in a set now will insure him years of enjoyment, to the life of the set—with no danger of obsolescence. If color ever supersedes black and white during the life of the set, he can have the adaptation made at a cost considerably less than the cost of a new set—especially of a set with built-in color adaptation. He will be getting something which is already tried and true, and which is operating on the commercial standard. Color is something for the future. As yet, no direct-view 16 or 19-inch color sets have even been demonstrated. Nor will the current popular TV shows be broadcast in color for a long time to come.

12. What should I tell the customer who has a set and is worried about obsolescence? Tell him that when the day comes that he finds that he is missing something by not having color, you will be equipped to adapt his set for color. It need never be obsolete.

RCA Contest Winners

First prize winner in the RCA tube department's "You Name It" contest, which was designed to find a name for RCA's new WO-57A TV Cathode-Ray Oscilloscope, is Mrs. Elizabeth French, Washington, D. C. She and her husband own and operate French's Radio Service Shop in that city. The winning name was "Scan-alyst." First prize was the WO-57A oscilloscope together with an RCA WG-214 Probe and Cable Kit. Second prize, and RCA 195-A VoltOhmyst, was awarded to James S. Bennett, Newington, Conn. Third prize, an RCA WP-23A Regulated Power Supply, went to Paul Silverman, Brooklyn, N. Y.

Gross Adds Line

Gross Distributors, Inc., 216 West 14th St., N. Y., and Gross Distributing Corp., 49 Edison Place, Newark, N. J., have announced their appointment as distributors for the Metropolitan New York, Long Island, Westchester, New Jersey, and Fairfield County, Connecticut areas, for the Murray Corporation of America, Home Appliance Division.

With RIDER MANUALS you can turn the tough TV repairs into "PUSHOVERS"

Don't waste time, patience and money trying to "dope out" the repair. Reach for your RIDER MANUAL! Just look up the make and model and follow the accurate, authentic servicing information!

NEW! Just Off the Press! And selling faster than any other manual we ever published! Make sure of your copy! Get it today!

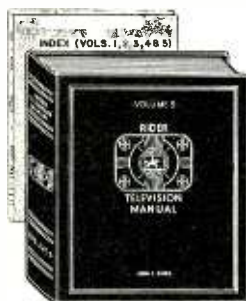

RIDER TV MANUAL Vol. 5

Authentic, Accurate, Reliable Servicing Information DIRECT From the Engineering Depts. of 74 TV Manufacturers!

RIDER TV MANUAL 5, the latest volume in the RIDER Library, covers all TV receivers manufactured up to July, 1950. All servicing information comes DIRECT FROM THE MANUFACTURER and is compiled by RIDER into easy-to-follow form. You can quickly trace the source of the trouble, and just as quickly do the required repairing. Tens of thousands of Service Technicians let RIDER TV MANUALS guide them on to the kind of servicing that means substantial time savings, satisfied customers, and more money in your pocket. ORDER YOUR TV MANUAL 5 from your JOBBER TODAY!

Larger page size, 12" x 15", with all pages filed in place. Giant pages are retained, but now have only one fold for easier handling and greater durability. Equivalent of 2320 pages (8½ x 11) Plus Cumulative Index Volumes 1, 2, 3, 4, 5.

Still being published at no increase in price..... \$21.00

NOTE: Are You Receiving your copy of "Successful Servicing?" It's a RIDER publication of intense interest to every Serviceman.
WRITE FOR IT!

NOTE: The C-D Capacitor Manual for Radio Servicing, 1948 Edition No. 4, makes reference to only one source of receiver schematics—Rider Manuals.

JOHN F. RIDER PUBLISHER, Inc., 480 Canal Street, New York 13, N. Y.
Export Agents: **Rocke International Corp., 13 E. 40th St., N.Y.C. Cable, ARLAB**

NOW ON PRESS!

... Place Your Reservation Now and Make Sure Of Getting This Valuable Copy from the First Printing. Demand is High! Quantity is Limited by Paper Shortages!



RIDER MANUAL Volume XXI

With a RIDER MANUAL Volume XXI in your Library you can sail through any servicing job on any AM-FM radio receiver built from December, 1949 through October, 1950... and the same goes for auto receivers, record changers, tuners, disc and tape recorders. All information comes DIRECT FROM THE MANUFACTURERS (61 of them) and is compiled by RIDER into easy-to-follow form. There are 586 models, 351 chassis, with all pages and double spreads filed in proper place. All you have to do is to look up the make, model, chassis in the index... and let the factory-authorized servicing information help you do a better, faster, more profitable servicing job. 1648 Pages Plus Cumulative Index Volumes 16 through 21.
Only \$18.00

RIDER MANUALS

Television Manual Volume 5 (Plus Index).....	\$21.00
Television Manual Volume 4 (Plus "How It Works" Book and Index).....	21.00
Television Manual Volume 3 (Plus "How It Works" Book and Index).....	21.00
Television Manual Volume 2—in new, larger page size, 12"x15". (Plus "How It Works" Book and Index).....	21.00
Television Manual Volume 1 (Plus "How It Works" Book and Index).....	18.00
Volume XXI.....	18.00
Volume XX.....	18.00
Volume XIX.....	19.80
Volume XVIII.....	19.80
Volume XVII.....	16.50
Volume XVI.....	8.40
Volume XV.....	19.80
Volume XIV to VII (each vol.).....	12.50
Volume VI.....	19.80
Abridged Manuals I to V (one volume)...	19.80
Master Index, Covering Manuals, Vols. I to XV.....	1.50
PA Equipment Manual, Vol. I.....	18.00

NOTE: The Mallory TV Service Encyclopedia, 1st TV Edition, makes reference to only one source of TV receiver schematics—Rider TV Manuals.

NOTE: The Mallory Radio Service Encyclopedia, 6th Edition, makes reference to only one source of radio receiver schematics—Rider Manuals.

RIDER MANUALS mean SUCCESSFUL SERVICING

Replacing Speaker Cones

Instructions for Proper Cone Installation*

May Often Save Replacement Cost of a Good Speaker

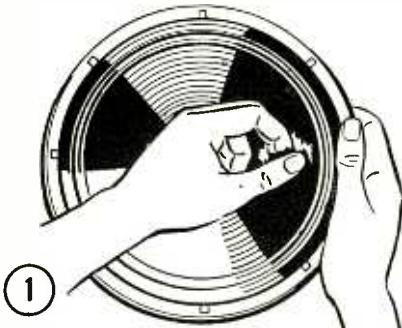

1

Remove old cone and voice coil assembly.

All speakers manufactured since 1940 use corrugated spiders made of cloth. For easier installation, we furnish speaker replacement cones for that type of speaker with the voice coil and spider separated from the cone. Instructions which follow are given in sequence, with illustrations, to aid you in this operation.

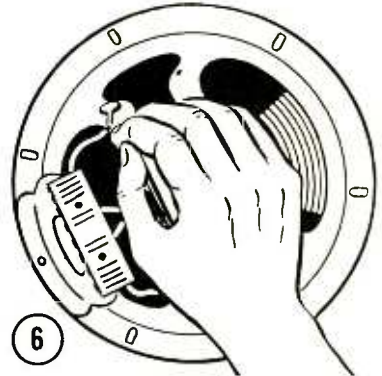

6

Cement paper ring and place in position, making sure mounting holes are lined up. Turn speaker on face and allow to dry thoroughly, at least two hours, preferably longer.

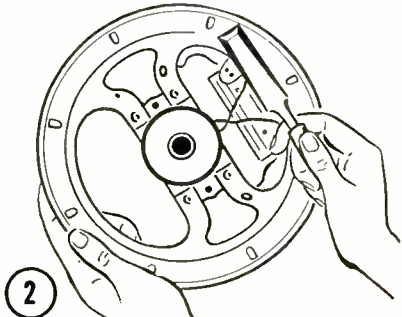

2

Scrape all glue or cement from cone and speaker mounting surfaces. (Soaking rim of speaker in warm water will help break down cement at that point. Be careful not to immerse speaker too deeply in water. Do not let water steam.)

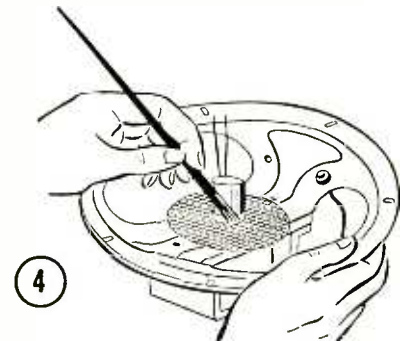

4

Put spacer or shim on inside of voice coil. Be sure voice coil leads are in vertical position. Apply cement to spider mounting surface and put voice coil and shim over pole piece. Be sure spider is level.

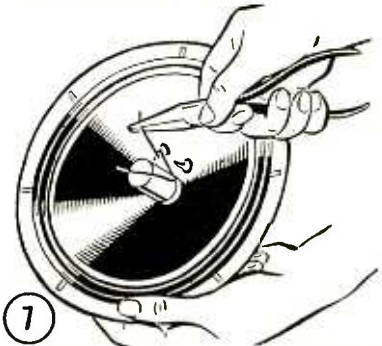

7

Bring voice coil leads to eyelets, loop around and solder. Solder voice coil leads from cone to eyelets of mounting, or lugs of terminal. Leave enough slack to allow free movement of the cone.

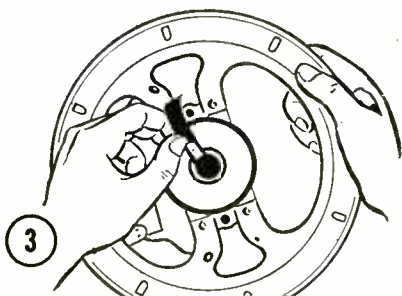

3

Clean pole piece of dirt and filings. Put scotch tape with sticky side out on shim stock, and push into gap. Hold shim steady and move speaker in rotary motion until all dirt and filings are removed. If air pressure or hand pump is available, it would help speed up operation, as it would blow out the dirt and most of the filings.

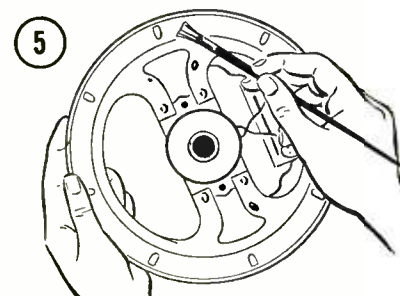

5

Apply cement to cone mounting surface and apply cement around neck of voice coil where cone and voice coil join.



8

Remove shim and place cement around voice coil where it meets cone. Put cement on eyelets where voice coil leads are soldered. Allow to dry and speaker is now ready for operation.

On inside spider cone types, follow the above instructions, with the exception of No. 4. In this case, use shim stock, about 1/4" wide in strips, and insert in gap, leaving these in place until cement is thoroughly dry.

On outside spider types, such as 2 point and 3 point cone types, follow our instructions with exception that you do not cement spider, as directed in paragraph No. 4. Screw spider down and center as directed above.

* These instructions were prepared by Waldom Electronics, Inc., Chicago manufacturer of replacement cones, and are reproduced by permission.

HOIST YOUR PROFITS

with a

JIFFY-UP Antenna HOIST!

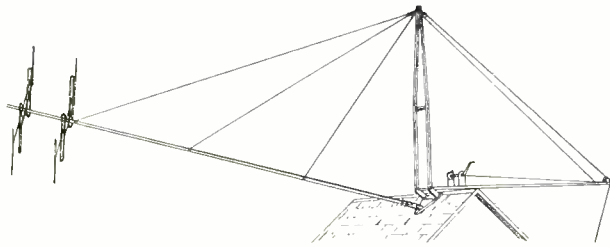

Two men can do the work of six in far less time. Eliminates the necessity of a big crew. Means lower costs, higher profits and savings in valuable time. All this can be achieved in your TV installations with a JIFFY-UP Antenna Hoist. Every dealer who installs TV antennas needs a JIFFY-UP Hoist.

1. Works on flat or gable roofs.
2. Installer uses specially-designed roof mount.
3. Hoist fastens to mount . . . can be put on and taken off in less than 5 minutes.
4. Antenna can be lowered at any time by fastening the hoist to the mount.
5. Will erect or lower masts up to 50' high.
6. Antenna mast can be self-guyed . . . takes only one man to crank it up.
7. Sturdy in construction—light in weight.

JIFFY-UP HOIST—Dealer net. . . \$49.50 *Pat's. applied for on both Hoist and Mount
 JIFFY-UP MOUNT—Dealer net. 6.00

If your dealer cannot supply, order direct from
THE HAUGEN CO.
 412 South Front St., MANKATO, MINNESOTA

PHOENIX

SPEED-MOUNTS and

HARDWARE



WILL REDUCE

....HIGH COSTS
CALLBACKS
INSTALLATION TIME

PHOENIX
 ELECTRONICS, Inc.
 LAWRENCE, MASS.



CONSUMER AND DEALER ACCEPTANCE



. . . everything your customers want in a

RECORD PLAYER

- superb tone quality
- faithful reproduction
- plays all speeds, all sizes
- proven and accepted nationally



*Varsity
Trio #539
one of the
17 Symphonic
models*

Now in one of the largest and finest equipped plants in the entire country, Symphonic production has tripled. This means better, faster service to satisfy the increasing demand.

BY THE MAKERS OF AMERICA'S FOREMOST LINE OF QUALITY RECORD PLAYERS

SYMPHONIC RADIO & ELECTRONIC CORP.

160 WASHINGTON STREET, NORTH BOSTON 14, MASS.

TOP DOLLAR VALUE

TOP QUALITY

TOP PERFORMANCE

NATIONAL DISTRIBUTION

NATIONALLY ADVERTISED

AMERICAN TELEVISION PICTURE TUBES REFLECT THE QUALITY OF AMERICA'S FINEST RECEIVERS

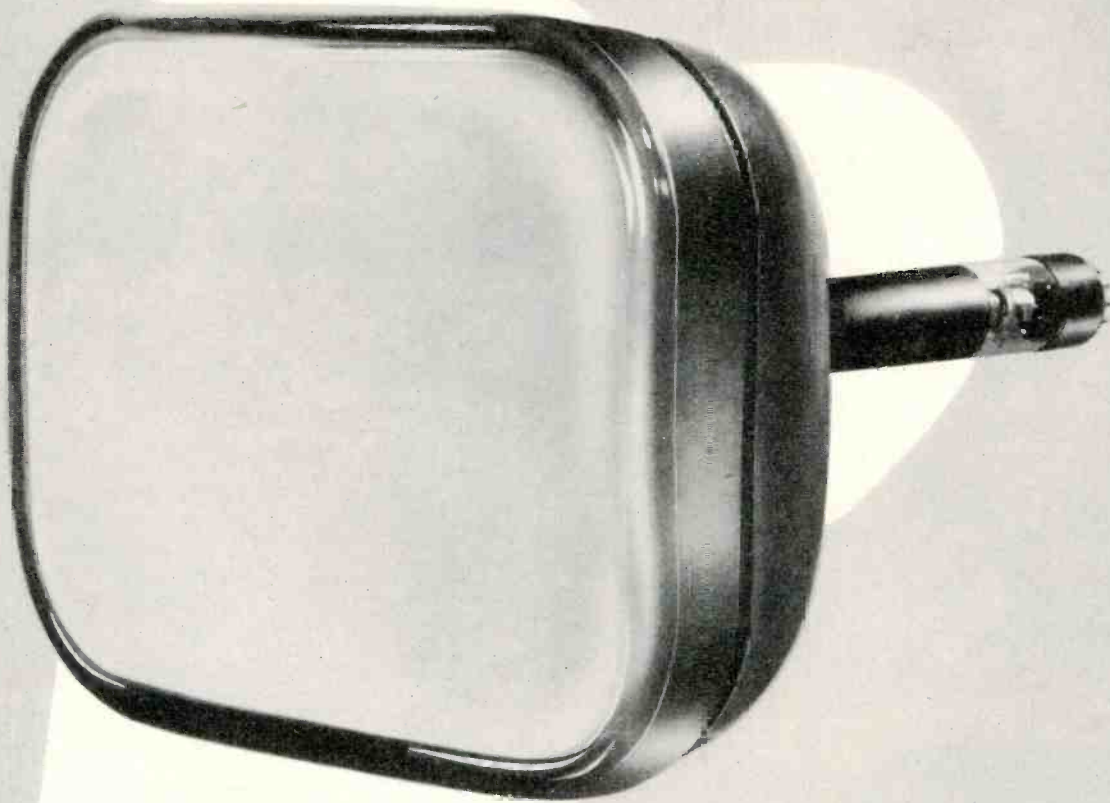

The history of the contributions of American Television engineers reads like the history of Television itself.

Our engineers are credited with hundreds of "Firsts"—the first amplifier tube, the first telecasting, the first interlaced scanning and, more recently, the first to develop the "Eyesaver" principle for picture screens—the high contrast, non-halation screen that has been widely adopted by the industry.



American Television is a "House of Fundamentals." Our "know-how" is constantly devoted to the further development of Television in all its phases.

The American Television Picture Tube is a great product of a great company. Make it your first choice—always!

AMERICAN TELEVISION

520 PLYMOUTH CT., CHICAGO 5, ILL.

MANUFACTURING DIVISION

THE STORY OF AMERICAN TELEVISION IS THE HISTORY OF TELEVISION

Does Your Time Selling Plan

**CUT INTO
YOUR
PROFITS**

or
**PROTECT
THEM?**

Sound reasoning prompts that question.

First, let's say flatly that most of your sales in these days are made to time payment buyers. Consequently most of your merchandise profit comes from this superior volume of sales.

But do you keep all this merchandise profit, or does too much of it slip through your fingers through the failure of your financing plan to protect it? Commercial Credit financing would protect your merchandise profits. Not only that, but it would increase your profit by helping you make more time sales.

Consider these advantages offered by Commercial Credit service:

- | | |
|-----------------------------------|---------------------------------------|
| 1. Wholesale Financing | 5. Property Insurance Protection |
| 2. Efficient Credit Investigation | 6. Automatic Sales Follow-Up |
| 3. Effective Collection Service | 7. Nation-wide Facilities for Service |
| 4. Life Insurance Protection | 8. Protection of Customer Good Will |

Unless your present financing connection renders you all these advantages, efficiently, you are bound to lose some of your rightful profits.

It pays to use Commercial Credit financing.



Helps Dealers Make

More SALES • More PROFITS

More SATISFIED CUSTOMERS

COMMERCIAL CREDIT CORPORATION

A Subsidiary of

Commercial Credit Company Baltimore • Capital and Surplus Over \$100,000,000

MORE THAN 300 OFFICES IN PRINCIPAL CITIES OF THE UNITED STATES AND CANADA

TO SOLVE ALL YOUR T-V SIGNAL PROBLEMS YOUR ONLY CHOICE IS TEC

TELEBOOSTER

MODEL
S-505

The S-505 is the same finely engineered design originally rated as "the Best Buy" among all the leaders. However, with a desire to make a "Better Buy"—the engineers at TEC have added a gain control and other electrical improvements. The gain control was found essential to reduce gain on some channels where the extreme gain of the S-505 blocked the front end. The S-505, a fringe area must, is available for immediate delivery. The wide-band flat response of this untuned Booster is ideal for inter-carrier sets for equal amplification of both picture and sound.



TELECOUPLER*

MODEL
S-501

The TEC TELECOUPLER* S-501 is the answer to multiple set operation from one antenna. Designed to operate 4-300 ohm or 8-75 ohm sets simultaneously, the S-501 can be cascaded to serve up to 12-300 ohm or 24-75 ohm sets—ideal for apartments. The S-501 matches 300 or 75 ohm sets in any combination and will operate with Hi or Lo antennas. Each antenna outlet is completely independent with no interaction. Now the dealer can operate all his sets at once and give the customer a true comparison to choose his set. The S-501 is ideal for small apartments, Radio dealers, and other multiple installations.



INDUSTRIAL TELEBOOSTER*

MODEL
S-503A

The S-503A is a wide band booster covering channels 2 through 13 without any switching and was specifically designed for use with the S-501 telecoupler in low signal areas.



TELECOUPLER JR. S-502

MODEL

The TELECOUPLER Jr. has been specifically designed for apartment use, and it may be wired internal or external to the building. Installed cost is low, usually averaging approximately the same as the cost of a separate antenna for an individual set. Maintenance and service requires a small annual fee. Installations may often be made on a tenant subscription basis at no cost to the owner. A planned installation with this unique electronic system removes unsightly antenna arrays and roof hazards—it is the logical answer to the apartment TV problem.

Write for Complete Bulletins R-2

*T.M. REG. AND PAT. APP.

TELEVISION EQUIPMENT CORP.
238 WILLIAM ST., NEW YORK 7, N. Y.
IN CANADA THE AMEREN & SOFER CO. LTD. OTTAWA

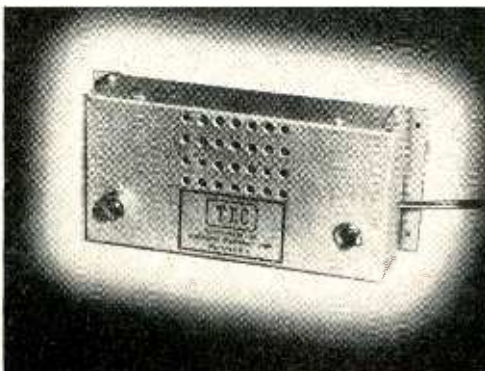

New Catalogs, Booklets, Bulletins & Pamphlets

Technical Appliance Corp., Sherburne, N. Y., manufacturers of Taco antenna equipment, announce Engineering Bulletin #64 which contains actual measurements in db gain over half-wave dipoles for all popular antenna types. The information is based on actual laboratory and field tests conducted at the Taco plant. The bulletin is designed to help servicemen in selecting the antenna type best for specific reception problems. Bulletin is free to any serviceman writing to Taco or through local jobbers.

Wright, Inc., St. Paul 4, Minn., makers of loudspeakers and associated equipment have made available catalog PC-No. 4 containing descriptions, illustrations and list prices of their line of PM speakers, speaker cabinets and grilles, baffles and transformers.

Mark Simpson Mfg. Co., Inc., Long Island City 3, N. Y., has announced catalog No. E-351 covering a new line of economy sound equipment, including amplifiers and complete sound systems from 8 watts to 52 watts for fixed, portable and mobile installations. Copies of the catalog may be had by writing the firm direct.

Astron Corp., 255 Grant Ave., East Newark, N. J.: Catalog AC-2 covers the complete line of dry electrolytics, molded paper tubulars, oil paper capacitors and the new "Metalite" self-healing, sub-miniature metallized paper capacitors. Also treated is a helpful listing of standard RF filters of aircraft and heavy duty applications. Copies of this catalog may be had by writing the manufacturer direct.

Weller Electric Corp., Easton Pa., offers a new, fully illustrated soldering gun catalog covering the complete line of Weller guns for every soldering requirement and features new light duty model with dual spotlights. Catalog gives detailed descriptions and list prices. A free copy may be secured by writing the firm.

Allied Radio Corp., 833 W. Jackson Blvd., Chicago, Ill., has released its new 1951 catalog (No. 124), a complete buying guide to everything in radio, TV and industrial electronics. The 212-page illustrated catalog covers component parts for radio, TV, sound and amateur radio, as well as kits and complete equipment. The catalog is available free on request.

Radio Corp. of America, Camden, N. J.: The RCA Tube Dept. has brought out a revised edition of the quick-reference booklet "RCA Receiving Tubes for AM, FM, and Television Broadcast." The new 24-page booklet covers more than 450 RCA receiving tubes and picture tubes including more than 50 new types. The booklet (form 1275-E) can be obtained from RCA tube distributors, or by sending 10 cents to Commercial Engineering, RCA Tube Dept., Harrison, N. J.

(Continued on page 88)

(Below) Miss Roberta Quinlan, beautiful and talented singing star of the *Wokaw* Showroom.



Right
**FOR SOUND
 AND SIGHT**



RAYTHEON
**RADIO AND
 TELEVISION
 TUBES**

Raytheons are Right... for Sound and Sight because they are designed by the pioneers and leaders in the field of radar and electronics — by engineers who never sacrifice quality of construction and performance for price.

When you *Replace with Raytheons* you give your customers finer visual and audio reception, a clearer picture, purer tone, and longer, more dependable performance. When you *Replace with Raytheons* you give yourself satisfied customers.

Ask your Raytheon Distributor about Raytheon Quality Tubes and about Raytheon's *Investment In Your Future* — the exclusive, business building RAYTHEON BONDED ELECTRONIC TECHNICIAN PROGRAM.

HOT OFF THE PRESS! The Raytheon TV Picture Tube Chart You've Been Waiting For! Contains complete physical and electrical characteristics — including basing diagrams — of all RMA announced TV Picture Tubes regardless of manufacturer. Compiled as a service to the field by RAYTHEON, this new chart is designed for wall or bench service book use. **FREE!** Write for your copy today. RAYTHEON MANUFACTURING COMPANY, Receiving Tube Division, Department C, 55 Chapel Street, Newton 58, Massachusetts.



Excellence in Electronics
**RAYTHEON
 MANUFACTURING CO.**
 Receiving Tube Division
 Newton, Mass., Chicago, Ill., Atlanta, Ga.,
 Los Angeles, Calif.
 RADIO AND TELEVISION RECEIVING TUBES,
 CATHODE RAY TUBES, SPECIAL PURPOSE TUBES,
 SUBMINIATURE TUBES, MICROWAVE TUBES
 Copr. 1950

The little **SHURE** cartridges
that fill the Big need
for High Fidelity
Phonograph Reproduction..

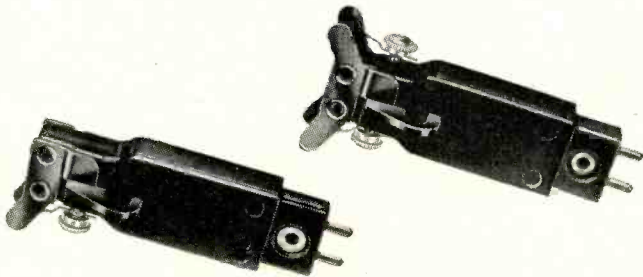

THE
NEW SHURE "VERTICAL
DRIVE"

CRYSTAL PICKUP CARTRIDGES

Big things often come in little packages . . . So it is with the superlative new Shure "Vertical Drive" Crystal Cartridges. They reproduce *all* the recorded music on the new fine-groove recordings—a reproduction that meets the strict requirements of high compliance and full fidelity. The "Vertical Drive" cartridges are requisite for the critical listener—the lover of fine music. They are especially recommended for those applications where *true fidelity* is essential.

SINGLE MODELS:
W 23 A for standard width-groove records.
W 21 A for fine-groove records.

TURNOVER MODELS:
W 22 A and W 22 AB for both standard and fine-groove recordings.

Unusually highly compliant, these "Vertical Drive" Cartridges will faithfully track standard records with a force of only 6 grams—micro-groove records with a force of only 5 grams (an added protection for treasured recordings). Will fit standard or special mountings. Have more than adequate output for the average audio stage.

See Your Shure Distributor for NEW Cartridge Replacement Guide with Handy Numerical Listing.



SHURE BROTHERS, INC.

Microphones and Acoustic Devices

225 WEST HURON STREET, CHICAGO 10, ILL. • CABLE ADDRESS: SHUREMICRO

BOOKLETS, ETC.

(Continued from page 86)

JFD Mfg. Co., Inc., 6101 Sixteenth Ave., Brooklyn 4, N. Y., announces the availability of its new 12-page television antenna and accessory catalog covering what is said to be the most complete assortment of TV installation items ever published. This literature is available from the manufacturer, its representatives and distributors.

International Resistance Co., 401 N. Broad St., Philadelphia 8, Pa.: catalog DC2S gives details on IRC's Concentric-kit stock assortment containing all necessary parts for easy assembly of 144 different concentric dual controls. Catalog available on request.

Jerrold Electronics Corp., 121 N. Broad St., Philadelphia 7, Pa., has issued a complete and detailed catalog on the Jerrold Mul-TV system. In the 2-color catalog full information is provided on installation and operation of the Jerrold Mul-TV system as used in apartment houses, hotels and other multi-unit buildings as well as in stores of TV dealers.

Sylvania Electric Products, Inc., Emporium, Pa., has published a new 12-page booklet in which characteristics of 194 cathode ray tubes for TV receivers, oscilloscope and radar applications are tabulated. Data includes heater current and voltage, nominal dimensions, basing, persistence and fluorescence of screen, maximum design center ratings and typical operating conditions. Copies of the booklet may be had by writing advertising dept. of the firm.

Clarostat Mfg. Co., Inc., Dover, N. H., has released data sheets covering TV control and resistor replacements. Following up on the first release covering RCA chassis, the latest sheets deal with additional RCA models, and with DuMont, Stromberg-Carlson, Crosley and Emerson models. The handy reference charts indicate model and chassis, stock and part no., Clarostat catalog no., price list, function and description. The sheets are obtainable directly from the manufacturer or through Clarostat distributors without charge.

Standard Transformer Corp., 3580 Elston Ave., Chicago 18, Ill., has published Stancor TV Catalog and Replacement Guide, Form 338. The 26-page catalog lists complete specifications and list prices of all Stancor transformers and related components for TV replacement or conversion, indexed for use in 618 TV chassis and receiver models of 64 manufacturers. The book may be had from Stancor or any of their distributors.

Irving B. Shurack, Inc., 1133 Broadway, New York, N. Y., has issued a 4-page catalog in 3 colors describing his line of Shura-Tone portable phonographs. Copies are now being mailed to distributors and dealers.

Superior Electric Co., Bristol, Conn.: Bulletin P550 covers "Powerstat" variable transformers for variable AC voltage control. The 16-page catalog gives full details on the complete line, with illustrations and notes on typical applications.

NEW INDICATOR ION TRAP

Now in all
**Rauland
Tubes**



The response to Rauland's new Indicator Ion Trap, after its introduction in the 12LP4-A, has been so enthusiastic that this feature has now been incorporated in all Rauland tubes—as a standard feature of the new Rauland Tilted Offset Gun.

In the field or on the assembly line, this new Indicator Ion Trap reduces Ion Trap Magnet adjustment time to a matter of seconds, eliminates mirrors and guesswork, and assures accuracy of magnet adjustment. It can increase profits for every service man and service dealer—and at the same time assure better customer satisfaction.

A bright green glow on the anode of the picture tube signals when adjustment is incorrect. Correct adjustment is made instantly, by moving the magnet until the glow is extinguished or reduced to minimum.

Only Rauland offers this advanced feature—one of a half-dozen important post-war developments from Rauland.

RAULAND

The first to introduce commercially these popular features:

Tilted Offset Gun

Indicator Ion Trap

Luxide (Black) Screen

Reflection-Proof Screen

Aluminized Tube



THE RAULAND CORPORATION



Perfection Through Research

4245 N. KNOX AVENUE • CHICAGO 41, ILLINOIS



NEW BOOKS

John F. Rider, Publisher, Inc., 480 Canal St., New York 13, N. Y.: New books now available include Television Manual Volume 5, which offers complete factory-authorized servicing data from 74 manufacturers for the period March through July 1950. This latest volume contains 614 models and 250 chassis in the equivalent of 2,320 $8\frac{1}{2}$ x 11 pages. TV-5 is priced at \$21.00. Also out is the new "Encyclopedia on Cathode Ray Oscilloscopes and Their Uses" by John Rider and Seymour D. Uslan. This 992-page book contains approximately 3000 illustrations and covers the theory and

operation of oscilloscopes, the application of scopes, schematics and circuit descriptions of commercial scopes produced in the last 10 years, and a compilation of 1600 complex waveform patterns. The book is priced at \$9.00.

The Macmillan Co., 60 Fifth Ave., N. Y., "Television for Radiomen," by Edward M. Noll, explains step by step, in clear, practical terms the operation of each part, and the installation, adjustment, alignment and trouble-shooting of today's commercial television sets. The 595-page book contains hundreds of diagrams and illustrations, and is priced at \$7.00, available at book stores.

Profit Plan

(Continued from page 53)

ers, stuffers and promotion pieces provided by manufacturers and distributors, plus mimeographed special forms highlighting new releases and the latest hits. These mailers serve to remind customers of records, in the first place, and the Jay-Bee Record Bar as the place to buy them. It has been found that in many cases, customers buy records in spurts. They may buy many records when they first get an instrument, and then not again for a long time—till a holiday season, or until some tantalizing hit gets them in the mood for records again, etc. The Russo store strives, by means of the monthly mailers, to keep in the eye of the customer all the time, to prod him to come in more often, and to "be around" when the mood strikes him again.

Another "gimmick" to build steady business is the "record club." The record club idea offers the customer a free record after a certain number have been purchased. A card is furnished to establish the validity of the claim, and the purchase may be stretched out over a long period of time. The desire to get something for nothing, however, encourages the customer to speed up the process. Very often, Mr. Russo states, a customer will try to get everyone in his or her family to buy a record so that they will be eligible for the premium record.

In addition to a large stock of standard and pop records, Mr. Russo has, in order to cater to an Italo-American community in his neighborhood, a large stock of Italian records, probably one of the largest in the country. This special service has paid off, not only in record sales, but in good-will and the continued patronage of these families and their children when they want other products.

Of course, the store does a large business in radios, TV sets, major appliances and traffic appliances, which enterprises we haven't highlighted in this article for the purpose of explaining in detail the record operation. The store also maintains its own service department for radio, TV and electrical work. Just one way in which the service department can be important was pointed out by Mr. Russo in discussing records: It sometimes happens that a record customer will call up or come in, irate because the record or records purchased "sound terrible." Since Mr. Russo knows his records are all right, a serviceman is sent to check the customer's phonograph. A bad needle, cartridge or defective audio amplifier is usually the offender. The customer is usually pleased to have the repair made, the service department gets a job out of the call, and the record department retains a customer.

Easy-Up Presents

NEW 4-Way ROOF MOUNT

FOR TV ANTENNA MASTS

Strong • Simple
Inexpensive • Rustproof
Tips up from 4 sides
Fits practically all needs

The new EZ-9 Mast Foot Mount fits peaked, pitched or flat roof. Anchors mast up to $1\frac{1}{2}$ " OD, by two $\frac{3}{8}$ " bolts with lock-nuts. (Companion model EZ-9A fits masts up to 2" OD.) Extra heavy-duty construction — all-steel (no welds), hot-dip galvanized overall for positive weather-proofing. Permits tipping mast up from any of four sides. It's everything you want in a roof mount.



DEALER PRICE
Model EZ-9 **\$195**
($1\frac{1}{2}$ ") only
EZ-9A (2") \$2.37

By the makers of Easy-Up Towers and complete line of pole accessories including Guy-Wire Clamps, Thimbles, Pole Rings and other Mast Foot Mounts.

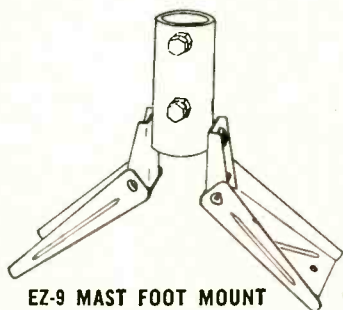

EZ-9 MAST FOOT MOUNT

Easy-Up Tower Co.

RACINE • WISCONSIN

For Greater Christmas Profits

Feature the Leader!



Revere
Magnetic Tape
Recorder

MODEL T-100
\$159.50
COMPLETE



So Outstanding, Revere Leads the Field

The professional quality and superior features of the new Revere Tape Recorder have made it the sensational leader in the entire recording field. No wonder dealers everywhere are reporting phenomenal sales of this remarkable equipment. Get behind this potent leadership for an extra share of Christmas profits!

Professional in Appearance and Performance

Revere's high-fidelity sound . . . easy, trouble-free operation . . . low price and economical upkeep . . . make it the outstanding value from any customer's viewpoint. Add to this such important features as a full hour of listening time on each reel . . . erasable, re-usable tape . . . simplified con-

trols . . . powerful, constant-speed motor . . . fast rewind and forward speeds . . . quick starting and stopping . . . time and footage indicator . . . plus a compact unit of handsome design and lightweight portability—and, Mr. Dealer, you've got terrific sales appeal!

Ideal Gift for Everyone

Every day, more and more people are discovering the many advantages of owning a Revere Tape Recorder . . . the fun it is to record children's voices and home talent . . . to add music and commentary to home movies . . . capture radio programs for future enjoyment. Schools, churches, and clubs find tape recorders invaluable for educational and recreational purposes. Business and professional people, musicians, and students—*everyone* will welcome the gift of a Revere Tape Recorder.

This wide-open market, combined with overwhelming preference, makes Revere Magnetic Tape Recorders the hottest new profit-builders you can carry. Write for complete information.

REVERE RECORDER-RADIO COMBINATION

Tape recorder plus a glorious toned radio. Programs can be recorded from radio by mere turn of a switch—no cords to connect. Powerful circuit, built-in antenna.

Model TR-200 \$199.50 complete



REVERE CAMERA COMPANY • CHICAGO 16

New JFD Representative

The JFD Manufacturing Co. Inc., of Brooklyn, N.Y., has announced the appointment of Charles E. Pheasant of Indianapolis, covering the territories of Indiana and Western Kentucky.

Named Ad Manager

The appointment of Stanley F. Zajac as advertising and promotion manager of the New Jersey branch of Motorola-New York Inc., has been announced by Nathan Cooper, president.

Air King Names Gardner

D. H. Gogan, president of Air King Products Co., Inc., Brooklyn, N.Y., manufacturer of TV receivers, radios and wire recorders, has announced the promotion of Mario A. Gardner to vice-president in charge of purchases.

New Allied Catalog

Allied Radio Corp. of Chicago has announced publication of its new 1951 212-page catalog, covering "Everything in Radio, Television, and Industrial Electronics."

Xmas Market

(Continued from page 45)

Direct-mail advertising, listing specific products on hand is bound to bring good results this Christmas, and they can also be made to serve a good-will builders if they carry a personal greeting from the store and its employees. A good idea is to include a list of the names of store salesmen and servicers under the greeting the store owner sends.

All in all, this Christmas season, while it's going to a tough one to operate in, offers a great opportunity to the dealer to strengthen his organization in meeting the many problems associated with buying and selling, and in doing his utmost to please every customer to insure a steady flow of business in good times and in bad ones, too. Good-will toward customers is not only a moral obligation but a business one as well.

A Monday 'Must' For Top Management . . .

MARTIN CODEL'S

AUTHORITATIVE NEWS SERVICE
OF THE
VISUAL BROADCASTING
ARTS AND INDUSTRY



Every Monday morning, hundreds of top radio executives start their working week by reading Martin Codel's newsletter, TELEVISION DIGEST. In only six years this service has become the "bible" of the policy-makers in every branch of TV . . . telecasting, manufacturing, distribution, and allied fields. Its list of subscribers is a literal "Who's Who" in TV and Radio.

TELEVISION DIGEST has reached this outstanding position because it does a thorough, authoritative job of reporting and analyzing trends and developments in TV . . . and does it in a minimum of reading time. If you need to know what's happening in America's fastest-growing industry, then you, too, should be a TELEVISION DIGEST subscriber.

A complete service • Weekly Newsletter • TV-AM-FM Directories • Weekly Addenda • Regular Supplements of Current and Permanent Reference Value.

Write or Wire for Samples & Rates



1519 CONNECTICUT AVE. N. W.
WASHINGTON 6, D. C.

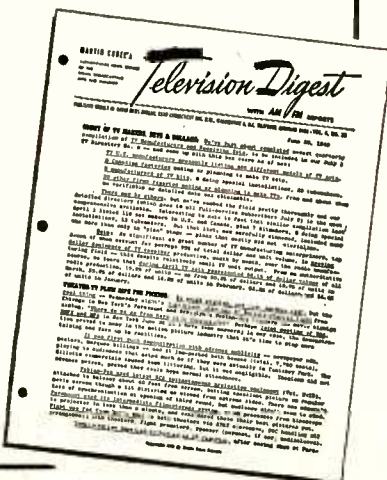

Newman Joins Ansley

Bernard Fein, president of Ansley Radio and Television, Inc., has announced the appointment of Seymour D. Newman, as national sales manager.

Cornish to Bigger Offices

Cornish Wire Company, Inc. has moved its general executive offices to greatly enlarged space at 50 Church St., New York 7, N. Y. This move was necessitated by the greatly expanded business of the company, which is making radio, TV and industrial wires, besides a complete line of cords, cord sets, etc.

Eureka Ad Campaign

Via the Belfor Advertising Agency, Eureka Television & Tube Corp., of Hawthorne, N. J., plans a wide advertising and promotion program for the immediate future, designed to acquaint the TV public and dealers with the technical advancements and quality standards set by Eureka.

Color TV Converters

Webster-Chicago Corp., which made the first color converters for use with the CBS system, has announced that it is prepared to market converters and adapters that will enable present sets to receive CBS color. However, the acute shortage of some parts and the need for tools and dies will prevent any appreciable production before the first of the year.

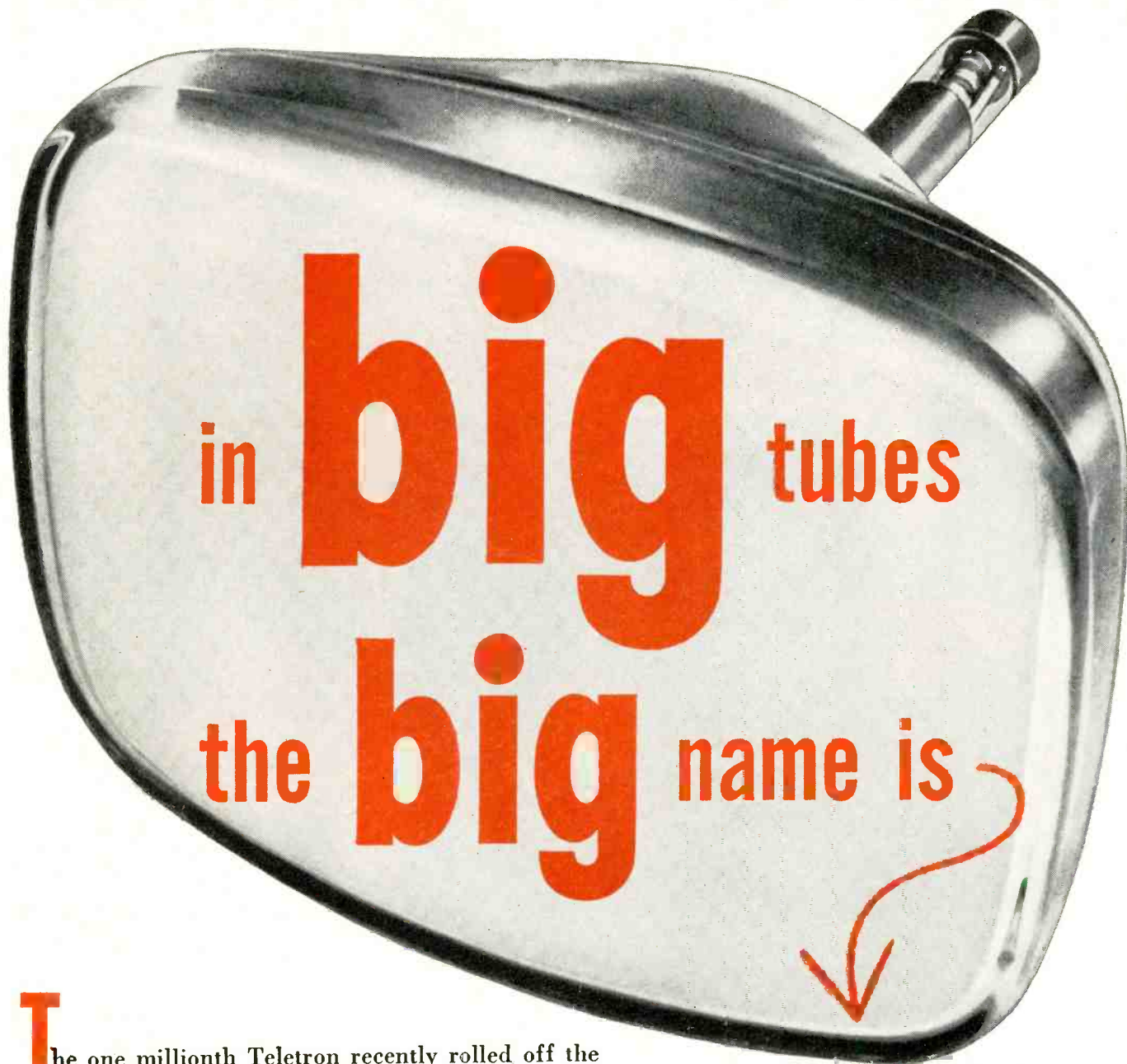

The one millionth Teletron recently rolled off the production line. It was all in the day's work for Du Mont's vast Allwood plant geared to over a million TV picture tubes a year. Yet that tube established a unique record, because it represented the one millionth BIG TUBE. No other manufacturer has made that many BIG TUBES.

Ever since 1939 when Du Mont introduced the first commercial television set with its 14" Teletron, Du Mont has pioneered BIG TV TUBES. While others were offering 7" and 10" tubes, Du Mont was satisfied with nothing less than 12". Even as early as 1939, Du Mont made 20" Teletrons. Since then the public and industry have followed the Du Mont lead, but Du Mont remains in the lead with still larger tubes climaxed by the 30" Teletron available shortly.

Obviously, in BIG TUBES the BIG NAME is DU MONT.

DU MONT
*Teletrons**

First with the Finest in Television

Literature on request

*Trade-Mark

ALLEN B. DU MONT LABORATORIES, INC.
TUBE DIVISION • CLIFTON, N. J.

Phono Record News

RCA VICTOR has released an album based on selections from "Happy Mother Goose," a new book of modernized nursery rhymes which is currently a best-seller in England. The collection was recorded by Burr Tillstrom, creator and impresario of the Kuklapolitan Players, and cast members of his network TV show, "Kukla, Fran and Ollie." This album marks the recording debut of the Kuklapolitans, and will offer a collection of songs, recitations and dramatic bits, with Burr Tillstrom masterminding

the production, Fran Allison handling the vocals, Kukla singing and doing character studies, and Ollie reciting nursery rhymes and also vocalizing. The book (Happy Mother Goose) was released in this country at the same time, and record and book promotions will implement each other.

CORAL RECORDS has signed comedian Jerry Lester, star of the TV show "Broadway Open House," to a recording contract. Jerry's first release features Milton De Lugg's song, "Orange Colored Sky," backed by another new song, "Time Takes Care of Everything."

COLUMBIA RECORDS have released a third volume of the best-selling "I Can Hear It Now" series, with Edward R. Murrow as narrator. Covering the period from 1919-1932, Volume III will be issued simultaneously on one LP (ML 4340) and in an album of five conventional 21-inch shellac records (MM-963). The technique used in the first two volumes of presenting the actual recorded voices and sounds of events has been used wherever possible in Volume III; but where recordings are either non-existent or of poor quality, faithful reenactments have been incorporated. Starting with Woodrow Wilson, and going through the period of bathtub gin, Lindbergh, Coolidge and Al Smith, the volume ends at the first inaugural of Franklin D. Roosevelt. It should prove at least as popular as were the first two volumes.

DECCA RECORDS has released the first albums in its "Gold Label" classical series. Featured is the original cast recording of Gian-Carlo Menotti's musical drama, "The Consul." A complete libretto is furnished with each album. In the popular field, the first Tommy Dorsey records have been released, following his recent signing to an exclusive 3-year contract with Decca.

MGM RECORDS has announced its first release of classical records. The company's new line will be known as the "popular Classics Series" and will feature material pressed on all 3 speeds. Albums in the series will be available almost exclusively on 33 $\frac{1}{3}$ and 45 RPM, although a few 78 issues are planned. Singles will be available in both 78 and 45 RPM. Among the albums in the first release is the first complete recording of the Tchaikovsky ballet "Aurora's Wedding," performed by the Royal Opera Orchestra of Covent Garden. The other orchestral album in MGM's initial release will be "A Promenade Concert," a collection of short orchestral masterpieces patterned after a typical concert at "The Proms," London's equivalent of our "Pops" concerts. Two other albums are included in this release, "George Copeland Plays Debussy," and three Preludes and Fugues for organ by Bach, played by Carl Weinrich. Among the new singles are operatic arias sung by Lauritz Melchior and Donald Dame.

CAPITOL RECORDS has released an album featuring the unusual Peruvian singer Yma Sumac. Titled "Voice of the Xtabay," the album is distinguished not only by the extraordinary voice of Miss Sumac, but also by the exciting and exotic themes and rhythms of the authentic Andean songs from her native Peru. The 24-year old beauty projects her voice from a tenor register to a coloratura's range, for a spread of four octaves.



KIND *to record*
 KIND *to ear*
 KIND *to purse*

the Magic Touch

Fidelitone

LONG LIFE PHONOGRAPH NEEDLES

FROM 50c to \$5.00

PERMO, Incorporated
 CHICAGO 26,

There's Real SALES PULL in these Facts about... GENERAL ELECTRIC SPEAKERS!

IT PLAYS UNDER WATER! Submerged in water, the G-E speaker continues to deliver sound reproduction day in and day out. Do you know of any other speaker that will take a similar beating? The answer is in G.E.'s waterproof Voice Coil...the hottest selling feature in any speaker today!



WHEN you're out to corral new business (and what smart dealer or serviceman isn't?) give yourself a head start by selling the line that's booming along today at a dollar volume 40% higher than last year's record...

General Electric speakers—from the 4" replacement unit to the famous 12" high fidelity champion—are packed with features that assure your customer superb performance and build his confidence in your workmanship. You'll make no mistake when you stock, talk, and sell General Electric speakers!

GREATER MAGNETIC POWER. The stronger the magnet the more sensitive the speaker. Iron filing clusters indicate comparative magnetic strengths...the Alnico 5 alloy used in G-E units is 2½ times as powerful as the standard material previously employed in magnet construction.

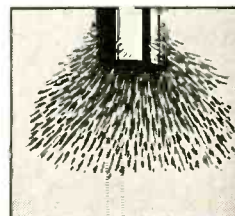
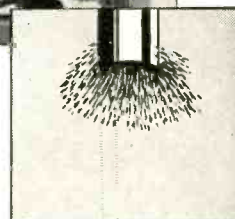

ALL WELD CONSTRUCTION. Rigid enough to support a man's weight, the G-E speaker housing is treated with bright-finish zinc plating...this enables the speaker to resist corrosion long after untreated models have begun to rust.

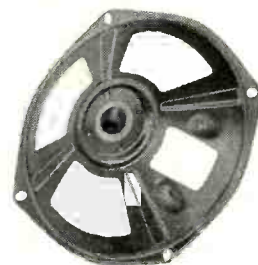

GENERAL ELECTRIC

GET THESE SALES AIDS

Start now to expand your speaker sales. G-E promotion kits help attract new business in home radios, portables, custom installations, drive-in theatres, P.A. systems... Send coupon for full information.



FREE BOOKLET!

General Electric Company, Section 26110
Electronics Park, Syracuse, New York

I'm interested in G-E Speakers. Send me new folder illustrated here.

NAME _____
ADDRESS _____
CITY _____ STATE _____

Blackstone Distributors

The Blackstone Corp., of Jamestown, N.Y., manufacturers of ironers, washers, and dryers, has announced the appointment of Southern Wholesale Co., Inc., 1565 Texas Ave., Shreveport, La., and J. J. Skinner & Co., Inc., 6523 Euclid Ave., Cleveland.

Henry Sarkis Moves to New Chicago Office

Henry D. Sarkis, manufacturers representative in the Chicago area, has moved his offices to new larger quarters at 6560 North Sheridan Road, Chicago.

Jones Joins Sams

Walter R. Jones, associate professor of electrical engineering at Cornell University, has been retained as a member of the editorial staff of Howard W. Sams & Co. Inc., Indianapolis electronics technical publishers and research laboratories, Howard W. Sams, president, has announced.

Capehart Sales Rep

Emerson Dickman, Jr., has been appointed special sales representative for the Capehart-Farnsworth Corp. in the New York region, E. Patrick Toal, Capehart's director of sales announced.

TV Sales

(Continued from page 62)

out front in the store. (See photo.) Ken Price claims that this is a most worthwhile feature, and plans in his new store to have both radio and TV service sections on the show-room floor. 20 to 25 live demonstrators are maintained at the store. These are hooked up to a Jerrold Mul-TV system.

The firm does a big business in radio sales and service, featuring small sets and combinations, and handles recorders, selling the latter to schools, doctors, lawyers, etc. Public address systems are sold and rented.

The Price firm goes after conversion and replacement business on record changers, modernizing them to play the three speeds, and finds this activity bringing in additional profits. It also helps to increase the sales of phono records which the store stocks. A strong believer in a diversified operation, Price handles electrical appliances, and is currently planning to expand this department.

The firm was established by Ken Price and his partner, H. Edmond Pratt shortly after the former returned from service as a Radar man in the U. S. Navy during World War 2. Plans are now under way to construct a 3-story building, featuring a 50-seat television "theater."

Operating in the heart of a rich farming district, the Price organization has truly gone places in a very short time. This success was not achieved accidentally. It is the result of continuing to build up a satisfied customer list by operating a store on a fair square basis in a community where a dealer surely "lives with his customers."

Starrett TV Showing

Spearheading a promotional and merchandising program in behalf of the all-new 1951 Starrett line of 17" and 19" TV sets, the Starrett Television Corp., in joint efforts with their newly-appointed New England distributor, A. E. Borden Co., 176 Brookline Ave., Boston, staged a 3-day showing recently at the Hotel Kenmore, Boston.

Good Test Equipment

Ralph R. Shields, engineer for Sylvania Electric Products, Inc., in an address at the Philadelphia Radio Servicemen's Association Convention said recently, "In factories producing more and more lower-priced TV sets of better quality, the answer is good test equipment." Shields said that the use of proper test equipment combined with good techniques reduces time required for TV servicing, increases the servicemen's profit and assures customer satisfaction.

The Christmas Gift
EVERYONE wants!



V-M

**tri-o-matic
PHONOGRAPHS**

automatic record selection

automatic shut-off

plays all speeds, all sizes

easy to operate

Sell your customers the gift that offers lasting satisfaction—the beautiful Portable V-M tri-o-matic 975, finished in handsome leatherette—or the smartly styled V-M tri-o-matic 970 for use in any room in the home. Both models have highest quality amplifying systems, and plug into any AC outlet. (A tri-o-matic replacement unit is also available.) For full details see your jobber or representative.

V-M CORPORATION Benton Harbor, Mich.

FOY ELECTRIC COMPANY, INC.

305 SOUTH MINT STREET TELEPHONE 3-4834

CHARLOTTE 6, N. C.



August 21, 1950

Hytron Radio & Electronics Corp.,
Salem, Mass.

Dear Sirs:

It is with great pleasure that I write you at this time to compliment you on the superior performance of the Hytron 16RP4 cathode ray picture tube.

I have just purchased one of the NEW _____ 16" table model television sets, model _____, for my own personal use. I was not pleased with the brown spot which is often found in the rectangular tubes so I replaced this new _____ picture tube with one of Hytron's. The result? Amazing! Actually clearer and sharper pictures, more brilliance and no brown spot.

We are authorized service for about 11 different makes of TV sets and _____ is one of the factories we serve. From now on we shall insist upon Hytron for all picture tube replacements.

Yours truly,

J. A. Gupton, Jr.
Service Dept. Manager

**WHY MR. GUPTON PREFERS
HYTRON RECTANGULARS...**

Thanks to Mr. Gupton. His unsolicited appreciation naturally warms our heart. More important, he gives all service-dealers an excellent reason for picking Hytron rectangulars.

Does he choose Hytron: Because the rectangular is Hytron's baby . . . the original leader? Because Hytron's picture-tube plant is the most modern in the country? Because nine out of ten leading TV set makers choose Hytron? Because more and more service-dealers show equal shrewdness?

He has an even better reason: experience. His own experience proves Hytron better. Hytron rectangulars give him amazingly clearer, sharper, more brilliant pictures. They'll do the same for you. Demand original Hytron rectangulars. Prove by your own tests that Hytron is also *your* best choice.

16RP4 Rectangular



MAIN OFFICE: SALEM, MASSACHUSETTS

Capehart Distributor

D. N. Latus and Company, of Helena, Montana, has been appointed distributor of the Capehart line for Montana and northern Wyoming. E. Patrick Toal, director of sales of the Capehart-Farnsworth Corp., has announced.

Shure Names Morin

Joe H. Morin has been named sales manager of the distributors' division of Shure Brothers, Inc., Chicago microphone manufacturer, according to an announcement by S. N. Shure, president.

To Distribute Coolerator

The A. A. Schneiderhahn Co., 319 S.W. Fifth, Des Moines, Iowa, has been appointed distributor of Coolerator electric ranges, refrigerators and home freezers, according to W. C. Conley, Jr., Coolerator general sales manager.

Thor Distributor

Thor Corporation has announced the appointment of National Sales Co., 365 North St., Rochester, N.Y., as distributor of its full line of products in the Rochester area.

Crosley Appointees

The appointment of Inwood Smith to the newly created post of assistant general sales manager in charge of all products for the Crosley Division, Avco Mfg. Corp., has been announced by W. A. Blees, vice-president and general sales manager. Blees said the appointment of Smith and several



Inwood Smith, assistant general sales manager.

other personnel changes have been made to integrate sales and expanding manufacturing activities more fully, and to provide greater efficiency in handling constantly increasing volumes.

Charles A. Stoup, who has been in charge of Crosley's kitchen equipment, was named as Smith's successor and was in turn succeeded by M. B. Beck, formerly in charge of kitchen sales in the company's Philadelphia regional office. Appointment of Donald F. Miersch as manager of the electric range and water heater section also was announced.

Tele-tone Ad on Color-TV

Full-page advertisement by Tele-tone headed, "Here's How You Can Have Color Television with Tele-tone 'Tele-color.'" Ad signed by S. W. Gross, president says deliveries will start January 1, and that the unit will be moderately priced. "Tele-color" is described as a light, compact unit that fits on top of console model, or serves as a stand for a table model set.

Urged to Buy TV Now

Pilot Radio Corp. used full-page ads during the height of the color-TV situation to tell readers that "Pilot wants to give you COLOR TELEVISION but not as a 'Flying Saucer.'" Illustration showed set with converter and adapter, headed "Not This!" Company urged customers to buy black-and-white sets with confidence; blasted the FCC decision.

NOW... 2 SPEED TAPE RECORDING

with EICOR

A natural for Bigger Xmas sales!

Hit the Christmas market hard with *two speed tape recording*. Eicor Model 115 converts from standard 7½" per sec. to 3¾" per sec. in less than 30 seconds. Max. 2 hr. recording per 7" reel. Make extra profits by selling 4150 kit for change-over. Kit lists at \$5.00.

LIST PRICE

\$144⁹⁵

Slightly Higher West
of Rockies



**ORDER NOW
IMMEDIATE DELIVERY!**

DEALERS: Cash in on Xmas sales NOW—
with Eicor, America's finest, low-cost tape recorder

WRITE FOR DISTRIBUTOR'S NAME TODAY!

EICOR, INC., 1501 W. CONGRESS ST., CHICAGO, ILLINOIS

R-A-D-I-O-N—A NEW WAY OF SPELLING:

SPEED!

1 Speedy Installations

Nowadays, you or your service men have to get around *fast*. Deliver a TV set—plug it into an outlet—hook on a *Radion*—there's your picture! You are on your way to the next job in minutes. That's the way most TV dealers really make their profit today. And that's why *Radion* is the standby of men who like to operate at a profit. They take a *Radion* in with *every* set—just "in case"—and they're on their way to the next call *fast*. It pays!

2 Speedy T-V Set-Sales

The quicker you get that sharp, clear picture on the screen, the sooner you put the prospect's money in your pocket and move on to the next sale. *Radion* has closed hundreds of thousands of sales just that way! Good deal? Call your jobber or mail coupon TODAY.

3 Speedy Unit Sales

As a "pick and pay" traffic item, *Radion* has proved an excellent volume-builder in hundreds of stores—a convenient package that tells its own story—saves salesmen's time—moves *fast*—particularly on replacement sales.

Radion

THE RADION CORPORATION

1137 Milwaukee Ave., Chicago 22, Ill.

**SPEED PAYS! GET
PROFIT-PACKED FACTS!**

MAIL COUPON NOW!

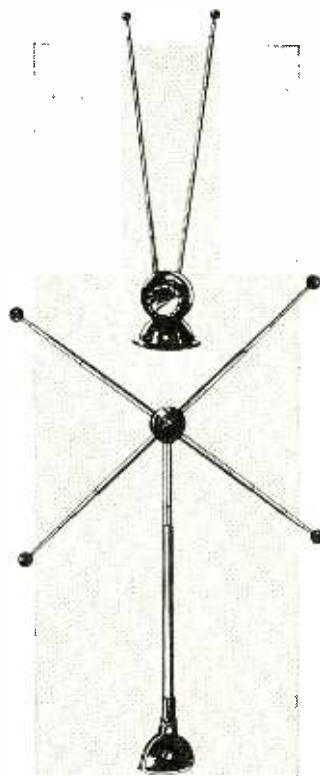

Over 1,000,000 sold!

The METROPOLITAN—TA-49

The industry standard, Model TA-49 indoor TV Antenna, Mahogany bakelite. 300 ohm lead-in line. 3-section telescoping tubular steel dipoles. Fully assembled. Individually packaged. Shipped six to a master carton. Shipping weight, 11 pounds. LIST PRICE, \$6.95.

Cinches "borderline" sales!

The SUBURBAN—TA-51

Model TA-51 Conical Outdoor Antenna. For wall, window or attic mounting. Weatherized ebony bakelite head. 300 ohm lead-in line. Four telescoping tubular steel dipoles, triple chrome plated. 4-foot telescoping mast. Steel base mount, black copper-oxide, rustproof. All channel coverage without adjustment. Fully assembled. Individually packaged. Packed 6 to a master carton. Shipping weight, 30 pounds. LIST PRICE, \$9.95.



Aristocrat of indoor antennae!

The COSMOPOLITAN—TA-55

Uniquely beautifully FOTO-TENNA specifically designed to blend with the finest interior decorating scheme. Beautiful brown leatherette, 11" x 14" closed, opens to approx. 22½" x 14". Complete with lead-in wire. Individually packaged. Packed 12 to a master carton. Shipping weight, 22 lbs. LIST PRICE, \$7.50.

THE RADION CORPORATION
1137 Milwaukee Ave., Chicago 22, Illinois

For Money-Making Data on Radion Products check here:

- Metropolitan No. TA-49 Cosmopolitan No. TA-55
 Suburban No. TA-51

Name.....

Company.....

Address.....

City.....Zone.....State.....

Allied Electric Reps

Two new manufacturers representatives have been appointed by the sales department of Allied Electric Products, Inc., Irvington, N. J.: George D. Norris Company of Seattle, Wash., and E. L. Berman Company of San Francisco.

Light Bulb Contest

Westinghouse light bulb retailers who take extra merchandising steps to back up a nationwide contest for consumers are offered \$3,500 in cash awards, including a \$500 top prize. A dealer must submit a photograph

of his tie-in window or interior display and write a letter of 100 words or less advising what he did to make the promotion a success. Contest runs until December 4.

Cletron Officers

Cleveland Electronics, Inc., Cleveland, Ohio, manufacturers of Cletron electronic and sound producing devices, has announced the following management appointments: Phillip J. George, president; Robert G. Hunter, vice-president; W. L. Allen, general sales manager; and Russel W. Shaffer, purchasing agent.

New TV Circuits

(Continued from page 77)

Run 4 in 24H1 and Run 5 in 24D1, 24E1, 24F1, 24G1

Resistor R448 added to 6CD6 screen grid to reduce parasitics. A 100 ohm, ½ watt resistor R448 (part number 60B8-101) was added to the 6CD6 screen grid as shown in schematic to reduce parasitic oscillations in this circuit. These oscillations will generally cause a double image with a "wavy" effect.

Run 6 in 24H1; Run 9 in 24D1; Run 10 in 24E1, 24F1; Run 11 in 24G1

Traps added to eliminate possibility of adjacent channel interference. Two adjacent channel traps L309 (27.25 MC) and L310 (19.75 MC) were added between the output of the TV tuner and the input of the 1st Video IF amplifier V301 (6AU6). This was done to eliminate the possibility of interference from the video carrier of the adjacent channel above and the sound carrier of the adjacent channel below.

This interference might be evident if two stations are operating on adjacent channels in the same locality, especially when the wanted station is weaker than the interfering station.

Check Need for Traps

Adjacent channel interference may take either of these two forms:

Adjacent Channel Video Interference. The picture has an interference pattern produced by the video carrier of the adjacent higher channel. Sometimes the interference will appear as a superimposed picture (stationary or moving slowly); at other times it may appear as a number of diagonal lines or as a vertical moving bar.

Adjacent Channel Sound Interference. The picture has a herringbone interference pattern produced by the sound carrier of the adjacent lower channel. Close examination will often reveal that the fine lines of the herringbone pattern vary in accordance with the speech or music on the adjacent lower channel. This can be checked by quickly turning the channel selector to this station.

Since these types of interference effects can also be produced by other sources of interference, and also by misalignment of the video IF's and traps, trouble from these sources should be checked before deciding traps are required.

The 19.75 MC trap will remove adjacent channel video interference, and the 27.25 MC trap will remove adjacent channel sound interference.

A complete Adjacent Channel Trap Assembly (includes L309, L310, C313, C314 and mounting bracket) is supplied under part number A3320.

Follow-Through

AN IMPORTANT TUNG-SOL CHARACTERISTIC



The sweep of a pitcher's arm after the ball is released — the arc of a golf club after the impact — that's the follow-through that makes for winning games and low scores. TUNG-SOL follow-through is equally important to you in making the most of radio and TV service opportunities in your neighborhood. TUNG-SOL follow-through is merchandising help.

Strong selling punch and quality mark all of TUNG-SOL's sales promotion material. Stationery, direct mail campaigns, displays, window valances, tool kits, shop coats, calendars, etc. — all are skillfully designed by nationally known merchandising experts to promote you — to build your business. Your name — your service gets top billing everytime on TUNG-SOL promotion material.

It costs no more to use the finest sales helps available. Some promotion items are free. Others are available to you at only a fraction of their cost. For example, the popular TUNG-SOL calendar with your imprint is the most economical calendar buy in the country.

If you are not aware of the sales helps to which you are entitled as a TUNG-SOL dealer, we suggest that you ask your TUNG-SOL distributor right away.

TUNG-SOL LAMP WORKS INC., Newark 4, N. J. Sales Offices: Atlanta, Chicago, Dallas, Denver, Detroit, Los Angeles, Newark.

TUNG-SOL SALES-AIDS FOR SUCCESSFUL SELLING



BOOST your sales with the NEW ALLIANCE BOOSTER*

Tenna-Scope, like Tenna-Rotor will be backed by national TV advertising that sells! No other booster will have equal acceptance!

For Tenna-Scope is superior in design for ease of operation and performance. One control for all channels! Automatic switch turns booster on with set. Superbly styled plastic control case blends with all furniture. Exceptional high-channel reception and uniformity of picture and sound! Price \$29.95.

Actual size—6¼" x 5½" x 5"



2 perfect companions:
***TENNA-SCOPE**
TENNA-ROTOR

Actual size—
6¼" x 5½" x 5"



New Deluxe
Model HIR Tenna-Rotor

New Automatic Tenna-Rotor—Model HIR—just set the pointer—antenna then turns to that point and stops. North—East—South—West. Direction indicator dial shows exact position at all times. May be marked for present or new channels. Guaranteed for one year. Uses special "Zip" feature, 4-conductor cable for fast installation. Advertised in all major TV areas.

Just set it — and forget it!

Alliance Manufacturing Co.
Alliance, Ohio

Export Department: 401 Broadway, New York, N. Y., U. S. A.

alliance
TENNA • SCOPE

Hallcrafters Sales Post

Michael D. Kelly, formerly assistant television sales manager of The Hallcrafters Co., has been named regional television sales manager for the central region, with headquarters in Chicago, it was announced by William J. Halligan, president.

Eureka Sales Regions

Creation of three new Eureka vacuum cleaner sales regions and the appointment of managers to head them has been announced by A. L. McCarthy, executive vice-president of

the Eureka Division, Eureka Williams Corp. The regions and their newly appointed managers are: Atlanta, W. H. Hayes; Dallas, E. R. Ascue; and Western, R. O. Boynton.

Webster-Chicago Distributor Appointed

Kierulff & Company, Los Angeles, has been appointed exclusive distributor in Southern California (with the exception of San Diego area) for Webster-Chicago on its new tape recorder plus all other consumer products including the complete line of phonographs and wire recorders.

Crystal Diodes

(Continued from page 79)

grid of the kinescope.

Of course, the uses for germanium diodes outlined in this article are but a few of the many possible uses. The purpose of this article was only to show uses found in current model TV receivers. Nor are all the many types of diodes which are available described here, but only those found in the aforementioned TV sets. There are some types which accommodate back voltages up to 200 volts, and there are some (silicon types) which are useful at frequencies up to 10,000 MC. More complete information on the various types may be had by writing for literature from Sylvania Electric, the General Electric Co., Raytheon Mfg. Co., and other manufacturers of germanium crystal diodes.

New Symphonic Plant

Moving of its entire plant and facilities into new and more spacious quarters was announced recently by Symphonic Radio & Electronic Corp. of Cambridge, Mass., through its president, M. H. Cogan. He said, "We



M. H. Cogan, president, of Symphonic Radio and Electronic Corp., Boston, Mass.

were fortunate in securing new manufacturing facilities in the huge building at 160 Washington St., North, in Boston, where the improved setup and enlarged space will enable us to triple our production to meet the increasing demand."

Appoint Patterson

W. S. Patterson has been appointed vice-president in charge of sales of the Grigsby-Allison Co., manufacturers of radio and electrical devices. The firm is located at 407 No. Salem Ave., Arlington Heights, Ill.

NEMA Annual Meeting

National Electrical Manufacturers Association is holding its annual meeting at Atlantic City, the week of November 13. Event will be staged at Haddon Hall.

VERSATILITY
VERSATILITY
VERSATILITY
OXFORD Speakers

ver-sa-til-i-ty . . . ability to change easily from one action, style or subject to another; power to do many things well. (*Webster's Dictionary*)

The Oxford Speaker line is extremely versatile in that there is a unit to meet every replacement need. Inventory is kept at a minimum because all Oxford Speakers have a constant demand. Eliminate overstocking by using this speaker line which has no obsolete models.

Regardless of the sound application, Oxford Speakers will solve each requirement . . . have the "power to do many things well".

Write for your copy of our new catalog today!

Leading jobbers carry OXFORD SPEAKERS for TV, FM, AM, AUTO and PA.



OXFORD ELECTRIC CORPORATION

3911 South Michigan Avenue • Chicago 15, Illinois

EXPORT: ROBURN AGENCIES, NEW YORK CITY

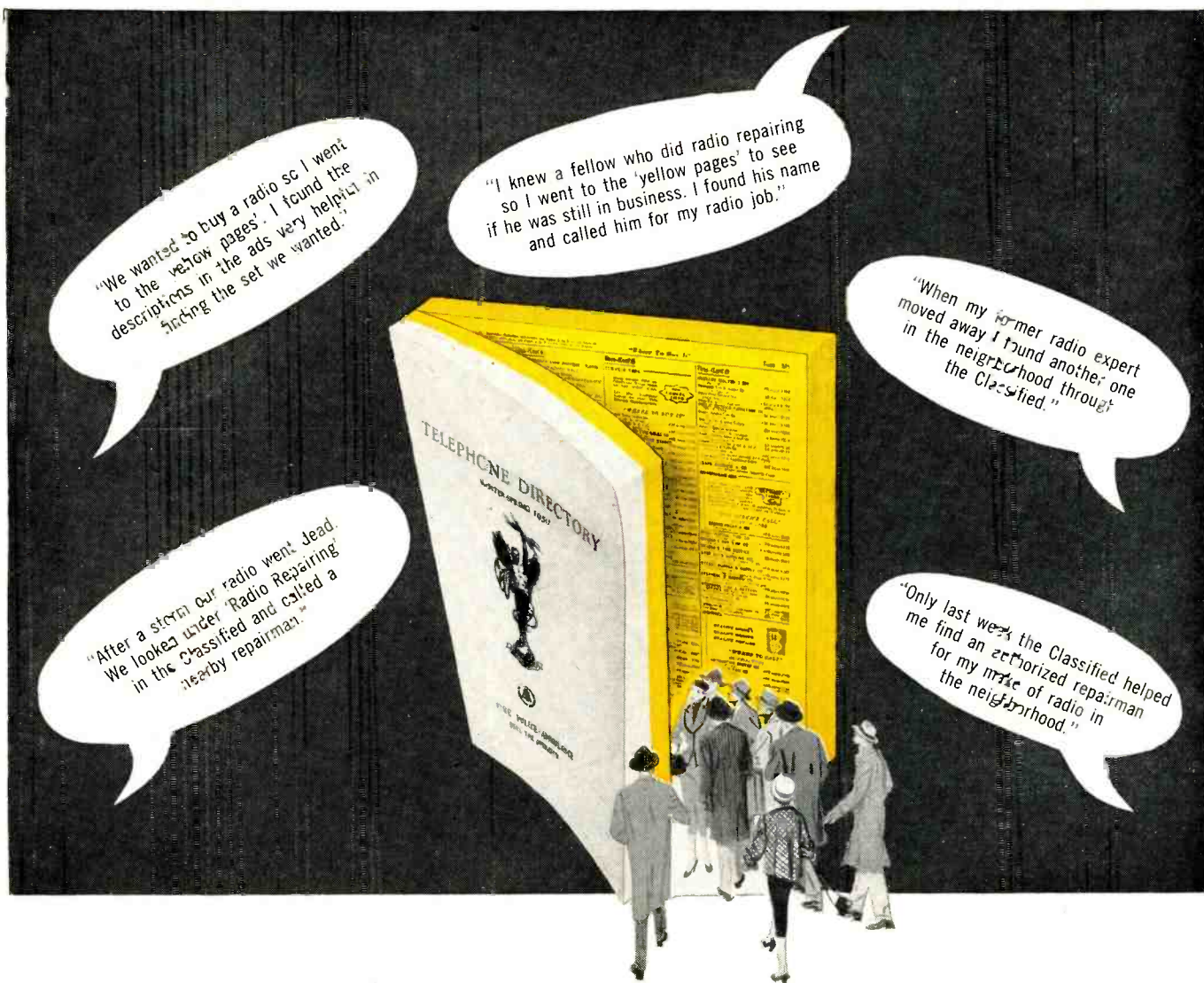

How the 'Yellow Pages' are building sales for Radio-Television Dealers

Statements like these prove that your advertising in the 'yellow pages' of the telephone directory can reach a lot of people who are *ready to buy*.

It is an established fact that 9 out of 10 shoppers depend on the 'yellow pages' for where-to-buy-it information. That is why so many radio and television dealers use the 'yellow pages' to increase sales.

Your advertising in the 'yellow pages' of the telephone directory not only goes right into the homes of prospects in your own town...it reaches newcomers and visitors in town as well.

Are you advertising under all the classifications where prospects are likely to look for the branded products and services you offer?

FOR FURTHER INFORMATION, CALL YOUR LOCAL TELEPHONE BUSINESS OFFICE.



TV Marches On!

(Continued from page 50)

in the operation of one's business. There must be cautious buying, courteous selling and as much long-range planning as is possible.

While many are protesting against the adoption of CBS color, optimistic folk are going ahead with the making and selling of monochrome sets; feeling quite certain that the consumer will be smart enough to realize that compatible color in a factory-made

complete unit isn't here yet, and, hence, will go on buying as usual.

While Regulation W with its new terms is the law, we'll have to live up to that no matter how hard it hurts, and, since the Government needs money for vital defense, we'll have to go along with excise taxes, and increased general taxes as a patriotic duty, firm in the belief that we will continue to do business at the old stand, though it'll be a little tougher.

Yes, the market is in a confused state, but it's still a vigorous market. Crepehanging will get us nowhere, but belief in our businesses, backed up with hard work and skilful piloting will keep us out of the red.

Admiral Distributor



The G. W. Onthank Co., Des Moines, Iowa, has been named the new distributor in that area for Admiral Corp., TV and appliance manufacturer, Wallace C. Johnson, Admiral vice-president in charge of sales, has announced. The new distributor's president and general sales manager is George W. Onthank, above.

GE Appliance Production to Drop 20% in 1951

General Electric appliance production will continue at its present pace through the next two months, but will drop off about 20 per cent in 1951, H. L. Andrews, vice-president in charge of the company's Appliance & Merchandise department, has predicted. Despite this decrease, Andrews said, "There is a very definite possibility that the appliance industry will have to do a more intensive advertising and merchandising job next year than at almost any time since the war."

Olin Appoints Evans

Robert H. Evans has been appointed executive assistant to the president and executive committee of Olin Industries, Inc., it was announced by John M. Olin, president. Evans resigned his positions as secretary, treasurer, and director of the Riegall Paper Corp. to accept his new duties with Olin.

Tele-Tone Names Ross



Malcolm Ross (above) has been appointed director of purchasing for Tele-Tone Radio Corp., it was announced by S. W. Gross, president of the company. Ross was formerly with Sylvania Electric Products Corp.



ANOTHER
"Green Gem"
TRIUMPH

THE NEW Rauland 32 WATT P. A. AMPLIFIER

Here's the universally applicable amplifier with remarkably complete P. A. facilities, unprecedented flexibility and brilliant new "Green Gem" styling. Features 3 microphone inputs (each convertible for use with a low-impedance mike by use of a plug-in transformer); 2 phono inputs with dual fader; true electronic mixing and fading on all 5 inputs; separate bass and treble tone controls; provision for remote mixing of 3 mikes. Housed in deluxe cabinet finished in new dark green hammerloid; metallic bronze control panel set in a perforated aluminum finish front section.

SPECIFICATIONS:

Power Output: 32 watts at 5% or less total harmonic distortion, measured at 100, 400 and 5000 cycles. 48 watts peak output.

Gain: Mike—128 db (2 meg); 115 db (100,000 ohms); 115 db (150 ohms). Phono—82 db (½ meg). Voltage required for rated output: High imp. input—.005; low-imp.—.0004; Phono—. 3 volts.

Frequency Response: ± 1 db, 40 to 20,000 cps.

Output Impedances: 4, 8, 16, 166 (70 volts), 250, 500 ohms.

Hum and Noise Level: 73 db below rated power output (unweighted).

Tubes: (10); 3-6SQ7, 3-6SC7, 2-6L6, 1-5U4G, 1-6X5GT.

The new RAULAND 1932 P. A. Amplifier offers maximum facilities, a world of dependable power, superb tonal performance, and distinctive new styling. This incomparable combination of excellence gives you a real selling edge. The RAULAND 1932 Amplifier is available for immediate delivery. Get full details on this outstanding new P. A. equipment today!

See your RAULAND-BORG Distributor for full information on the complete RAULAND Public Address Line—the line that builds Sound profits.

Electroneering is our business

SOUND
EQUIPMENT

Rauland

INTER-
COMMUNICATION

RAULAND-BORG CORPORATION • 3523-L Addison St., Chicago 18, Ill.

FOR THE FINEST IN QUALITY

IT'S...

EUREKA



Produced for...
CLARITY and DURABILITY

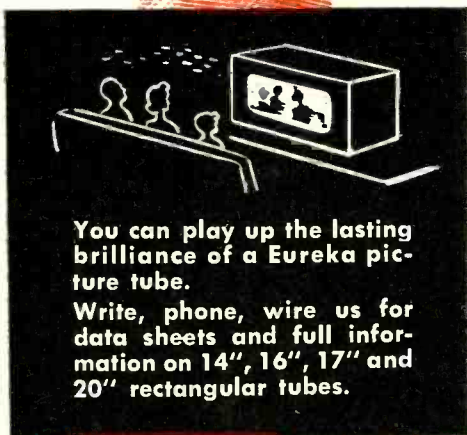

You can play up the lasting brilliance of a Eureka picture tube.

Write, phone, wire us for data sheets and full information on 14", 16", 17" and 20" rectangular tubes.

Eureka Standards are the highest.

No "Rush" production schedules have been permitted to change our standards of work.

That is why rejects of Eureka cathode ray picture tubes run to less than one-half of one percent.

That is why you can trust Eureka to ship you the best in kinescopes every time.

EUREKA TELEVISION AND TUBE CORPORATION

Manufacturers of Cathode-Ray Tubes and Electronic Products

69 Fifth Avenue, Hawthorne, New Jersey

Telephone Hawthorne 7-3908

Low Price on Towers?

**"TO GET TO THE BOTTOM
YOU HAVE TO GO TO THE TOP"**

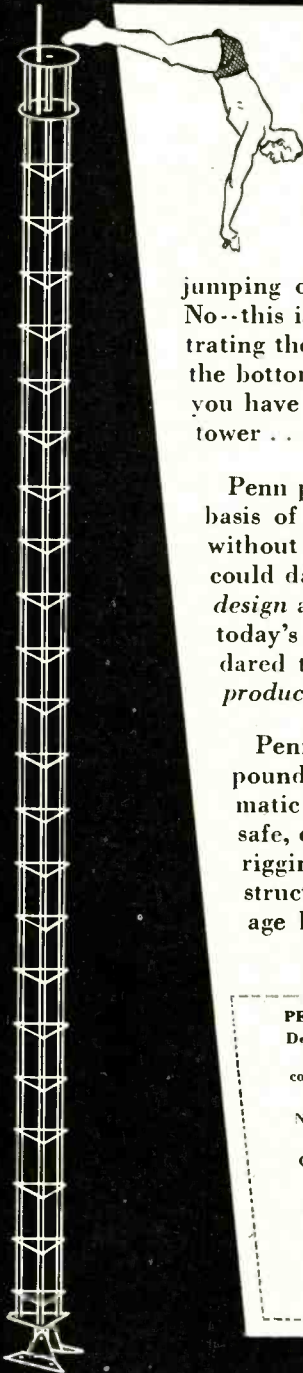

Have "deals and whispers" on tower prices got him so confused he's decided to solve it all by jumping off one of the d----d things? No--this is just our screwy way of illustrating the fact of the matter: To get to the bottom of the tower price situation, you have to go to the maker of the top tower . . . the Penn Teletower.

Penn prices low on the straight, open basis of *superior mass production* . . . without benefit of "deals." Only Penn could dare to offer a tower *improved in design* at a *reduced* price in the teeth of today's market . . . for *only* Penn has dared to go "all out" in applying *mass production technique* to tower making.

Penn towers weigh less than two pounds a foot . . . feature exclusive, automatic pilot hole alignment that permits safe, easy 2-man erection without use of rigging hoists . . . provide sectional construction that cures inventory and storage headaches.

New, Free Price List!

PENN BOILER & BURNER MFG. CORP.
Dept. N2, Lancaster, Pa.

Please send me a copy of your Teletower Bulletin, complete with new retailer price list.

Name

Company

Address

CANADIAN REPRESENTATIVE:

J. R. McVity & Company

53 Dalewood Road, Toronto, Ontario, Canada

PENN Teletowers
Liftowers

PENN BOILER & BURNER MFG. CORP.
LANCASTER, PA.

**Brach Showings in
Nationwide Campaign**

Brach Manufacturing Corp., 200 Central Ave., Newark, N. J. has inaugurated a nationwide campaign to acquaint the television dealers with the new Brach antennas and the sales potentiality of the Brach Multi-Tel System. The first of these showings was held at Holman Radio in Bradley Beach, N. J.

Coin Operated TV

Covideo, Inc., manufacturer of coin-operated television sets, is in full production on its new 14" set which had its first showing last spring. Operators of Covideo coin-operated TV sets report excellent activity from hotel, motel and tourist court locations. The firm is in New York City.

Three New Distributors

Three new distributors have been appointed for the Andrea line of television receivers. They are: D'Elia Electric Co., Inc., Bridgeport, Conn.; Ramsey-Bennett Co., Cleveland, Ohio; and Bowers Wholesale Corp., Norfolk, Va.

**Full Retail Prices, New
Webster-Chicago Policy**

Webster-Chicago Corp. has announced new policy designed to protect dealers from loss of business through preferential price discounts to consumers who should be paying the full retail price. The firm has informed its distributors that all catalogs, advertisements and other announcements directed to the general public should carry full retail prices.

New Counter Card



The recently introduced Snap-On TV Fuse Holder, by Littelfuse of Chicago, can now be had on a sturdy counter display card (above). Arrow in the picture shows that the card can be hung on wall as well as placed on the counter. There are 24 fuse holders on the card and a clear, self explanatory picture which shows how to use the holder for repairing pigtail fuses.

I was robbed!



"THEY TOLD ME . . .
 The "X" brand was the cheapest antenna on the market . . . And it was. They told me I could save 25% . . . but I didn't! In fact, it was the most expensive antenna I ever bought."

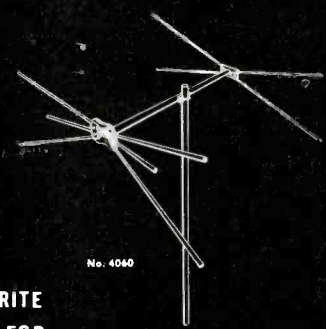

No. 4060

"I LEARNED THE HARD WAY . . .
 Costly service calls to repair or replace inferior, off-brand antennas quickly eat up a dealer's or installer's profit. Now, I'm convinced . . . it just isn't profitable to buy or sell a 'cheap' antenna. It's either good or it's costly."



No. 4062

QUALITY SELLS WALSCO ANTENNAS

- Silicone-treated, styron molded insulator.
- Marine-type high tensile chromium aluminum alloy used throughout.
- Reinforced elements, sealed on outer end.
- Sturdy, durable design and simplified erection.
- Extra gain on all channels.

WALSCO

"WalSCO Quality Earned Its Reputation"

WALTER L. SCHOTT CO., BEVERLY HILLS, CALIF. • CHICAGO 6, ILL.

WRITE FOR FREE ILLUSTRATED CATALOG 95-R

New PA Customers

(Continued from page 75)

pleasant will have a definite sales edge over his competitor. How about selling him a small amplifier, automatic record player (or tuner) and a few speakers?

Airplane Broadcasting

This method of commercial advertising is slowly coming to the fore but requires specialized know-how. Sound equipment manufacturers can usually provide literature describing installations in various types of planes, power supply requirements, types of amplifiers and microphones, radius distribution in terms of plane speed and height, and CAA regulations. Visit your local airport. You will probably pick up some sound business you never dreamed existed.

Chamber of Commerce

These are but a few of the sources for new business. Why not make a special effort to contact the principals of these firms and convince them of the necessity for sound? The names of these firms can usually be obtained from the local Chamber of Commerce. In addition, this agency is often aware of prospective industry additions months before they materialize, giving you advance notice of new prospective customers.

Wide Range Systems

Quality conscious home owners are prospects for a better sound system for their home entertainment. Some times the addition of a "tweeter" speaker to an existing system or instrument will provide sufficient extension of range to greatly increase the satisfaction of your customer.

Colleges, outdoor concert shells and churches are excellent potentials for sound systems requiring an extended response range. Plan a direct mail campaign bringing to their attention the fact that there are now weather-proof outdoor speakers with large power-handling capacity and at the same time with wide range audio response.

Sound Demonstration Rooms

Around the country, with no exceptions, the companies who have installed sound demonstration facilities are realizing dividends far beyond the modest investment involved. Many of your customers will want to see and hear the equipment you're trying to sell them. And also, a demonstration in which the customer can really hear the wider range of more expensive equipment often clinches the sell-up.

You can increase your sound business if you're willing to key your efforts in the directions described in this article. Although not intended as a cure-all, the suggestions are basic ones which alert sound men have already proven to be business-getters.



**The PROFIT-WISE
Serviceman Specifies . . .**

New
STANCOR PRODUCTS



**8400
POWER
SERIES**

A comprehensive line of 35 part numbers designed for replacement and new construction. Wide range of applications based on a thorough study of today's power transformer needs. Most ratings available in a choice of vertical or horizontal mountings.



**OUTDOOR LINE
TO VOICE
COIL**

Two new units designed to fit most needed outdoor applications. Primary impedances of 3,000/2,000/1,500/-1,000/500 ohms; secondary impedances of 16/8/4 ohms. Part Number A-3333 rated at 14 watts. A-3334 rated at 25 watts.

STANCOR TRANSFORMERS

Using Stancor replacement transformers for your radio, TV and sound service jobs is the sure way to fatten your bank account. Here's why —

- Quality comes first with Stancor. Ability to "take it" cuts down call-backs—keeps your customers happy with a good job.
- Stancor has the largest line in the industry. A choice of 450 part numbers, in some 30 mounting and terminal styles, enables you to get exactly the right unit for almost any application.
- Easy-to-read instruction sheets and clearly marked terminals make your job quicker and easier. Saves valuable shop time.

New Stancor units are coming out all the time. Keep posted. Ask your Stancor distributor for our latest catalogs.



Most Complete Line in the Industry

STANDARD TRANSFORMER CORPORATION 3586 ELSTON AVE., CHICAGO 18, ILL.

HAVE YOU A JOB FOR A TRAINED TECHNICIAN?

We have a number of alert young men who have completed intensive training in Radio and Television Repairing. They learned their trades thoroughly by working on actual equipment under personal expert supervision. If you need a trained man, we invite you to write for an outline of our course, and for a prospectus of the graduates. No fees, of course. Address:

Placement Manager, Dept. P110-10

COMMERCIAL TRADES INSTITUTE
1400 Greenleaf • Chicago 26

Recordette in the Movies

Recordette, the recorder, radio and phonograph portable combination manufactured by the Wilcox-Gay Corp. figured prominently in a recent motion picture release by Warner Brothers. The versatile instrument was in the camera's eye for ten minutes during a scene involving the recording of police conversations by gangsters. The picture, "Kiss Tomorrow Goodbye," features James Cag-



ney, Steve Brady and Barbara Peyton in the title roles. The picture is scheduled for showings in theatres throughout the country this fall. According to Verne Roberts, Wilcox-Gay sales manager, the company will prepare a complete promotion kit with newspaper and radio advertising, point-of-sale materials and theatre lobby displays for the dealers to use during local promotions.

Universal Distributor

Landers, Frary & Clark has announced the appointment of the Central Queens Electric Supply Company of Jamaica, N. Y., as its distributors of ranges, water heaters and home laundry equipment in the New York City area, with the exception of Westchester County.

New Recording Tape



Jack Karns, sales manager of Recoton Corp. has introduced Recoton's new magnetic recording tape for all tape recorders. This new tape comes in sturdy six spoke reels which turn true and resist warping. Each tape is guaranteed for thousands of recordings and playbacks. It is available in 1250 and 625 foot lengths.

Sprague, Gross Address Wholesalers on Color-TV

The right answers can hold sales, reassure customers—Say public won't go for "gadgets" . . . "Right kind of color system isn't here yet."

• More than 600 distributors, together with direct-to-dealer manufacturers and field representatives attended a meeting at New York's Bar-bizon-Plaza. The meeting stressed the need for prompt and effective briefing of all dealers in the New York metropolitan area. Robert C. Sprague, president of RTMA explained the operation of the CBS color system. He said that the right kind of color system isn't here yet; that consumers and sponsors will be reluctant to invest in sets and time until good color programs are on the air. Mr. Sprague explained that the picture being broadcast in color as received on adapted black-and-white sets, will be of poor quality. He said further that the public will not go for gadgets, and cited FM converters as an example.

Urging the importance of giving the customers reliable, accurate information, Mr. Sprague told of a dealer who received a cancellation on an expensive Du Mont set as a result of the color publicity. This dealer, who handles several makes, went to the customer and showed him the five reasons for buying black-and-white sets now as outlined in a General Electric Co. dealer bulletin. The customer "cancelled the cancellation" —bought the receiver.

Benjamin Gross, prominent New York distributor, and an officer in the NAED, presided at the meeting. He said that clear-cut, honest answers to customer questions will result in sales now. He listed the three most important questions to answer as follows: 1. "Will my set become obsolete?" 2. "Shall I buy now?" 3. "Can I get color on my black-and-white set?"

Mr. Gross said that the man who puts off buying a black-and-white TV set now, with all the fine programs on the air, is like the man who keeps putting off buying an automobile—"he'll get his first ride in a hearse." Mr. Gross urged all distributors and field men to get right on the job briefing dealers, making sure that the right kind of explanation is given to the prospective purchaser. Mentioning the large ad and publicity campaigns, Mr. Gross intimated that the nation's distributors might tie in with them using space and, perhaps time on the air. Those attending the meeting were urged to send telegrams to U. S. Senator Lehman and to others in Washington.

The speakers stressed the need for utmost caution in preparing advertising copy to be read by consumers. Such copy, they pointed out, should present the color situation fairly and accurately.

Phono Record News

NATIONAL RECORDS' Eileen (Bake A Cake) Barton is expected to duplicate her earlier successes with her latest, "Baby Me," set in a rousing vaude framework.

CORAL RECORDS have signed Denny Vaughan, one of England's favorite entertainers, to an exclusive recording contract. He will be groomed as a singing-bandleader, it was announced. The 27-year old native of Toronto, Canada has been in England for the past six years, and has developed into one of

Britain's top vocalists, pianists and arrangers. Connie Haines, one of the first stars to be signed by Coral Records when the label was formed almost two years ago, inked a new long-term contract recently.

CAPITOL RECORDS has announced the recording of "Daddy's Last Letter," by Western star Tex Ritter. The disc is based on a feature story carried by the Associated Press recently concerning PFC McCormick's last letter to his two daughters. Royalties will go to the widow, Mrs. McCormick.

PROFIT

With Another PENTRON "FIRST"!

NEW DUAL SPEED TAPE RECORDER

\$167.50

COMPLETE

Super sensitive crystal microphone. Reel of fine grain recording tape. Plastic take-up reel.



Model
9T3

2-Speed Recording, Playback! Super-Speed Forward, Rewind!

Only Pentron Offers You all these features in one instrument. Dual Speed utilizes the latest electronic developments and has performance characteristics found only in far more expensive recorders.

2 Full Hours of recording and playback at 3 3/4" per second or one hour at 7 1/2" per second on the same standard 7" reel. Dual Speed has a fast forward speed of 20 to 1 for making quick selections.

Easy, Fool-Proof Operation—Automatic features prevent accidental erasure, spillage and tape breakage; make operation simple as ABC.

A Step Ahead Of Tomorrow . . . Available Today!

ACT NOW! BE FIRST TO OFFER YOUR CUSTOMERS DUAL SPEED

Exclusive Features

EDITING KEY permits correction on any section of tape while playing.
DISTORTION-FREE record-play head permits full tonal range.
MAGIC EYE control for easy, accurate recording and playback.
INTERLOCK prevents accidental erasure, tape spillage, breakage.
JACKS for microphone, external amplifier, speaker, radio.

Export Agents
Scheel International, Inc.

Approved by Underwriter's Laboratories

PENTRON
DUAL SPEED
 TAPE RECORDER

THE PENTRON CORP.

221-C East Cullerton St., Chicago 16, Ill.

Send me detailed literature and information on open territories.

Name

Firm

Address

City State

CIRCLE X ANTENNA

ENGINEERED TO PROVIDE
**CLEAR SHARP
 PICTURES ON
 ALL CHANNELS**

COMPARE CIRCLE-X
 TO ANY OTHER TV ANTENNA

No other antenna combines all the mechanical and electrical features engineered into the Circle-X.

The high gain of the Circle-X is equal to stacked arrays. It is made of light weight corrosion resistant aluminum alloys that stand up in all atmospheric conditions.

When you use Circle-X you stock only one type of antenna for all jobs. It has one wire lead-in and weighs only 2½ lbs.

We urge you to compare Circle-X TV Antennas to any other TV antenna on the market.

Use Circle-X on your next tough TV installation. It may save you a lot of "no profit" call backs.

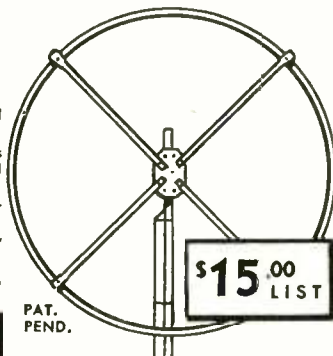

PAT.
 PEND.

DEALERS: Air Express or Parcel Post Special Delivery direct from factory to you through your jobber, if he cannot supply you with the Circle-X from his stock.

CIRCLE-X ANTENNA CORP.
 502 MARKET ST., PERTH AMBOY, N. J.

CIRCLE X
 ANTENNA CORPORATION

*Crowning Over a Quarter Century
 of Proven Quality*

DEWALD

presents its NEW 1950 LINE

**High Definition TELEVISION
 and Superformance RADIO**

Here is TV at its best—in 19", 16" and 14" table models and consoles—all with Built-In Antennas, Engineered for sure satisfaction and dependable, trouble-free performance.

And a complete line of portable and table radios as well as radio-phono combinations that spell increased sales and profits.

AT NEW LOW PRICES!

QUALITY
 SINCE
 1921

JOBBER-REPRESENTATIVES: Some choice territories now available. Write for full information.



19" King-Size
 Model DT-190

in
 RADIO
 and
 TELEVISION

for
 SOMETHING
 BETTER,
 it's

DEWALD

DEWALD RADIO MFG. Corp. 35-15 37th Ave., Long Island City 1, N. Y.

To Sales Post



The Brach Mfg. Corp. has announced that Jerome Berger, above, who was formerly manager of their devices division and plant superintendent, was promoted to the sales department as assistant sales manager of all Brach TV and electrical products.

Hotpoint House

"The Hotpoint House of the Fifties," a new all-electric house incorporating a pushbutton kitchen and laundry and many other advanced automatic products was opened at Plandome Mills, N. Y., recently by James J. Nance, president, Hotpoint, Inc., Chicago. Nance said that the house and its variety of equipment is a completely integrated unit dramatizing the advancements made in home building and related industries over the last 25 years.

New Distributors

Four new television distributors recently appointed by the Hallcrafters Co., Chicago, are: Appliance Merchandiser, Inc., 806 Hayden St., Fort Wayne 4, Ind.; Indiana Distributors, Inc., 321 East Washington St., Indianapolis, Ind.; Graybar Electric Co., 1702 Cullen Blvd., Houston, Texas; and Louis O. Bowman, Cary St., Richmond 19, Va.

Universal Award



The Society of Motion Picture Art Directors awarded this unique plaque to Landers, Frary & Clark for its Universal Select-A-Range, which, they said, "embodies the most advanced concept of design, and beauty of design" in the major appliance field.

Arvin Distributor

Arvin Industries, Inc., has announced the appointment of Edgar A. Brown, Inc., as the distributor for Arvin radio, TV and electric housewares in Cleveland, Ohio. At the same time it was announced that Frank Merritt has been appointed southeastern district manager in charge of TV and radio sales. He will make his headquarters at Atlanta, Ga.

Scare Buying Ended

"Scare buying of home appliances and television receivers, which resulted from the international crisis, we are glad to say, has ended," W. A. Bles, vice-president of Avco Mfg. Corp. and general sales manager of the Crosley Division, said recently. "Spot shortages of some appliances have developed in certain areas," said Bles, "but the halt in scare buying will ease these situations and soon all of us may be using every sales technique we know to sell."

Allied Officers

Stockholders of Allied Electric Products, Inc., at the annual meeting of the corporation elected seven directors for the corporation. Five of the present directors were re-elected for another one year term. They include: Nathan Chirelstein, president; Charles Penk, vice-president; James Schrope, assistant secretary; Stanley Newton, assistant treasurer; and J. J. Samuels, assistant to the president and purchasing agent. Two new directors were elected: Samuel E. Magid and Clermont Cartwright of Hill Thompson & Co., investment brokers of N. Y.

Trad "Giant" TV Sets

Giant TV sets for military and naval training centers are being made by Trad Television Corp., Asbury Park, N. J. Named the "Commander-in-Chief," the new sets boast a 30" x 40" picture.

DuMont Appointee



Joseph H. Moss, Jr. (above) has been appointed to the newly established post of manager of distribution for the receiver sales division, Allen B. DuMont Laboratories, Inc.

New Shobe Home

Shobe, Inc., began business in January, 1945 with four employes. In that first year, sales volume was \$331,000. Now there are about 60 employes, and sales each month are well over the first year's total. This Memphis, Tenn., firm, which now



P. Y. Blackwell (left), kitchen specialist for Shobe, Inc., distributor in the Memphis, Tenn. area, discusses the plan for a modern kitchen with a customer and the dealer who brought her in, Ray Dunn of Dunn, Baskin & Dunn, appliance dealer.

handles nine nationally known lines of appliances, is celebrating a move into new quarters, a block long building with 43,000 sq. ft. of floor area incorporating some of the most ingenious modern ideas for functional service to dealers yet achieved by any distributor.

To Sales Post

William A. Ready, president of the National Company, of Malden and Melrose, Mass., has announced the appointment of Arthur E. Champagne as New England district sales manager.

Starrett Sales Manager

R. D. Burnet, president of Starrett Television Corp., has announced the appointment of M. W. Craddick, as sales manager of the Metropolitan New York and New Jersey areas. Also announced was the new post of vice-president in charge of engineering within the administrative staff of the corporation. Edmond Sherman, who has been chief engineer, was promoted to that position recently.

Product Carries the Show

Bob Martin, Toledo manager for Allied Music Sales Corp., distributors of Webster-Chicago phonographs and wire recorders, puts on a late-evening full-hour music and patter show together with Mrs. Martin. Called "The Bob and Kathy Show," it goes out over WTOL every Saturday, whether Bob is on the road, in Chicago or resting comfortably at home. The program is recorded on a Webster-Chicago wire recorder and played back over the air.

For Autumn & Winter Market

Meck FALL TV LINE

Along with two models retained in the fall line are five new sets. The new 14 and 16-inch table top and console models use rectangular tubes, all have built-in antennas. The 14-inch table model (MM-614T) lists for \$179.50; 14-inch console (MM-614C), \$229.50; the 16-inch table model (MM-616T) at \$219.50; and the 16-inch console TV receiver, (MM-616C) at \$259.50. The new 19-inch rectangular tube console, (MM-619C) lists for \$349.50. John Meck Industries, Inc., Liberty St., Plymouth, Ind.—RADIO & TELEVISION RETAILING.

Burgess FLASHLIGHTS

The "Finelite," another addition to the flashlight line, has been announced. Chromium plate case is pen-type. Uses



two Burgess #7 cells. Shown here are a package of twelve on a special display card. Burgess Battery, Freeport, Illinois.—RADIO & TELEVISION RETAILING.

Music Master PHONO

Latest model added to the line is the model 151 shown here. In luggage type cabinet, covered in assorted colors of



alligator leatherette, it features lightweight tone arm and crystal cartridge. List price is \$25.95. Tone Products Corp., 225 W. 17 St., New York, N. Y.—RADIO & TELEVISION RETAILING.

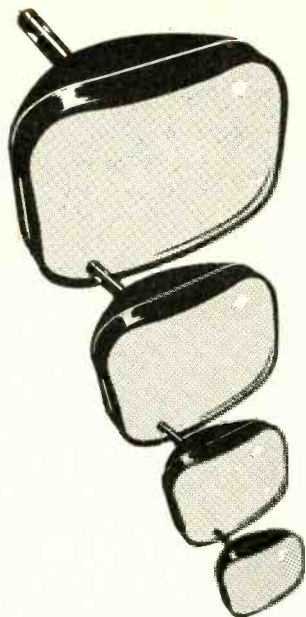

ELECTRONIC BUSINESS MACHINES

That's what we call the 16", 17" and 20" rectangular neutral-density-filter tubes that Reeves Soundcraft Corp. is manufacturing as successors to Remington Rand's TV Picture Tube Division.

IT IS GOOD BUSINESS to INCORPORATE Reeves Soundcraft "TRULUMES" as the BUSINESS end of TV sets you manufacture, service, convert, or for which you stock tubes.

In the coming months more and more of these fine rectangulars will become available. An inquiry NOW will enable us to tell you how YOU may sooner become one of our happy kinescopic beneficiaries.

Dictate an inquiry today.

Reeves — 20 YEARS WITH ELECTRONICS IN PEACE AND WAR: Optical and magnetic film sound recording facilities, equipment, and supplies; "acetate" discs and magnetic tape; transformers; projection TV; crystals; electronic computers.

REEVES Soundcraft CORP.

COLORCRAFT PICTURE TUBE DIV.
35-34 36th STREET, LONG ISLAND CITY 6, N. Y.

SUCCESSORS TO REMINGTON-RAND TELEVISION PICTURE TUBE DIV.

Ad Campaign by RTMA

Big advertising and publicity campaign launched by Radio-Television Manufacturers Association bringing reassuring information to owners of black-and-white sets, and to prospective purchasers of same. Dealers being helped a lot by manufacturer ads explaining the color situation to the public, and by letters manufacturers and jobbers are sending out to retailers.

Ironite TV Show



Helen Lewis, who plays the role of "Martha Wayne," wardrobe mistress, in the new Monday night, Ironite sponsored TV show, "Hollywood Screen Test", is shown explaining the operation of an Ironite automatic ironer to Neil Hamilton, former silent screen star who is master of ceremonies for the TV show.

DuMont Mechanical Man

Allen B. DuMont Laboratories, Inc., has come up with a highly successful merchandising stunt for local television dealers in the person of "Silo, the Mechanical Man," a human with an uncanny ability to imitate a robot. He appears for three hours daily at 15-minute intervals at a dealer's store for as many days as the dealer wishes. Silo has his own special uniform with DuMont emblazoned on it and his own window displays. He also trims windows while imitating a mechanical man. And when not actually demonstrating sets on the floor or in the window, Silo gives the dealer a goodwill boost by appearing at local children's hospitals, benefits, etc. on the dealer's behalf.

NEW CATALOGS

Standard Coil Products, Inc., 2329 North Pulaski Road, Chicago 39, Ill., has announced the availability of a complete listing of all TV receivers now being manufactured. Marketing and technical data on each of the 724 models is included. Copies will be sent on request.

Rek-O-Kut Co., Inc., 38-01 Queens Blvd., Long Island City 1, N. Y., makers of high fidelity recording and transcription equipment, have issued a catalog covering their line of turntables, cutting equipment, disc recorders and playback equipment. The catalog is available without charge by writing the firm direct.

Highest Quality

for CUSTOM

INSTALLATIONS

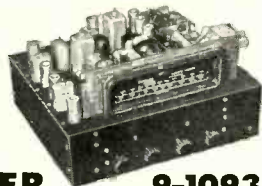

MEISSNER 9-1093 AM-FM TUNER • AMPLIFIER

Those who want to offer their customers the finest at modest cost will find the MEISSNER 9-1093 AM-FM Tuner and Amplifier perfect for custom installations.

It is one of the widest-ranged, purest toned amplifiers on the market. It handles all tones the human ear can hear, with a full 18 watts output at less than 2% harmonic distortion.

Compare its quality and price with all others . . . discover for yourself why it's MEISSNER for magnificent reception!

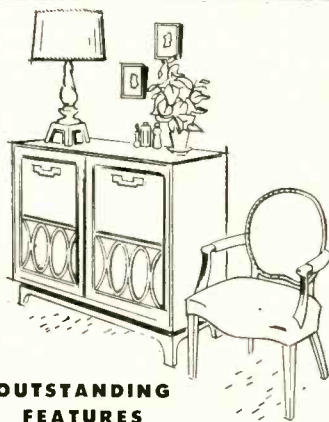

OUTSTANDING FEATURES

- Separate AM & FM circuits
- AM circuit features dual band width I. F
- PHONOGRAPH INPUT: Compensated for either magnetic or crystal pickup.
- TONE CONTROL: Combination control provides bass boost up to 11 db at 40 CPS and treble attenuation up to 13 db at 10,000 CPS.
- ARMSTRONG FM with double conversion of signal.
- No additional pre-amplifier required to use variable reluctance phono pick-up.
- ANTENNAS: Two indoor supplied, provision for connecting external AM and FM

WRITE TODAY FOR ILLUSTRATED 9-1093 FOLDER

MEISSNER for Magnificent Reception!

MEISSNER MANUFACTURING DIVISION
MAGUIRE INDUSTRIES, INC., MT. CARMEL, ILLINOIS

GE Tube Campaign

A large scale consumer advertising campaign on television picture tubes was launched recently by the General Electric tube divisions. G. A. Bradford, advertising manager of the tube divisions, pointed out that, until now, GE tube advertising had been addressed exclusively to the trade and to industry. "These programs will be continued," said Bradford, "but will be supplemented and supported by the new advertising series."

Bressler Expands Staff

Jules Bressler, 1780 Broadway, N.Y. 19, N.Y., has announced the appointment of Milton Baum to his sales staff in order to give the jobbers in his territory more intensive sales coverage. Baum will also render additional assistance to jobbers by analyzing their inventories and making suggestions for equalizing such stocks on key lines covered.

Certified's Largest

The Certified Appliance Co., Inc., has opened its third and largest store at 1559 Westchester Ave., Bronx, N. Y. With plans under way for two new branches in the near future.

Arvin Ad Program

Arvin Industries, Inc., has announced to its distributor and dealer organization "the biggest advertising program in all Arvin history" for the company's 1950-51 sales drive on television and radio sets. A 24-page "Fall and Winter Merchandiser" points out that Arvin ads in 16 national magazines will make 265-million "sales calls" during the next few months.

Hotpoint Key-Man Conference in Wisconsin



"Fit to fight on any front" was strategy theme of recent Hotpoint three-day Key Man conference at a Wisconsin resort. To dramatize hard-hitting field force, general sales manager, E. R. Taylor (right) trotted out his district managers on stage. First, they appeared as "strong men" in tights, then as suave businessmen with brief cases. Left to right are J. F. McDaniel, assistant sales manager; D. W. Renneman, Seattle; H. J. Scaife, San Francisco; J. N. Thompson, Kansas City; M. M. Mowbray, Dallas; M. K. Brody, Chicago; A. A. Borgemenke, Cincinnati; J. T. Nee, Zone Manager, Atlanta; J. E. Brickenden, Cleveland; H. B. Cromleigh, Philadelphia; J. S. Hicok, New York; and F. L. Cashman, Boston.

Mr. Executive:

**Here's The Best ADVERTISING
YOU Can Get.**

"The Jones's Are Getting Television!"

That's the story grapevined to the entire neighborhood even before the set is unloaded. Here is an excited television-minded audience. Here is the place where your service men can really do a job selling your service. Your men dressed in personalized, distinctive Master Work Uniforms tells this select audience, "Here's a first-class Television Set installed by first-class television men."

The cost of this effective advertising medium is surprisingly low! Without obligation, write for complete information.



IMPORTANT!

If You Do Not Know The Name Of The MASTER Representative In Your Locality — Write Us, And We Will Have Him Call On You.

GEO. MASTER GARMENT CORP., Dept. T-11 Ligonier, Indiana

NEW SIGNAL BOOSTING BARB CITY TV ANTENNA... the "Channel Buster"

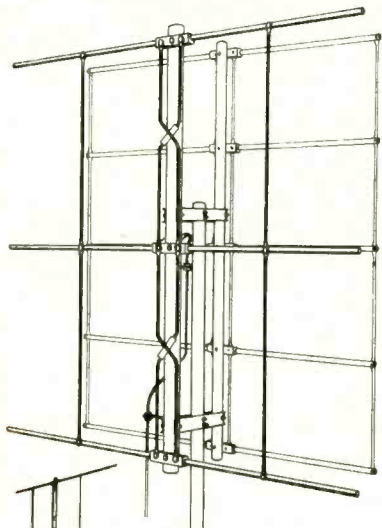

See your Distributor
or Write for Details

Actual Fringe Area Tests Prove 3 to 5 Times the Over All Gain of Other Good High Gain Antennas.

- All Channel Super High Gain Performance
- Tunable Reflector Provides 30 to 1 Front-to-Back Ratio on Desired Channels. Rejects Interference.
- Exceptionally Rugged. Light Weight Construction.
- Uses Single 300 Ohm Line
- Uni-Directional
- List Price Only \$45.00. Liberal Discount.

Engineering comparisons between the Channel Buster and other standard fringe area antennas will be furnished upon request. Get the surprising facts—today!

BARB CITY INDUSTRIES, INC.

1150 SOUTH 4th STREET • DEKALB, ILLINOIS

"Won't Buy CBS Color"

"This color controversy is really much ado about nothing—except for the bad and harmful publicity, there would be little for the trade to worry about. The real meat of the thing, which everyone seems to overlook or is playing down is the question of whether or not the public will actually buy CBS color. We say *NO!* They won't buy CBS color despite FCC approval, because as long-time radio merchandisers, we know that mechanical, motor-driven gadgets won't sell."—From bulletin to dealers by Harry Alter Co., Chicago distributors.

New Emerson Display

Emerson Radio & Phonograph is releasing a compact new plastic and wood identification display—tying in with its television program and national advertising. The unusual feature is the effect of an expensive illuminated display whereas no electricity is required. The disc is in pale green fluorescent plastic and the letters reflect light with a surprising intensity. The base is solid wood, finished in mahogany with the copy in ivory lacquer.

Sprague Goes on Air

Robert C. Sprague, president of the RTMA explained the industry's views on color television to the public, over the CBS radio network Sunday, Oct. 22, at 5:45 to 6:00 p.m. EST. CBS made its network facilities available to Sprague in response to his request for time to reply to the remarks made by Frank Stanton, CBS president, over the same network the previous Sunday.

Miniature TV Tubes

Sonotone Corp., manufacturer of hearing aids, has started production of miniature electron vacuum tubes for radio and TV sets, Irving I. Schachtel, president, has announced. The tubes are being made in Sonotone's new receiving tube plant. "Sonotone will concentrate on the key types of tubes with special characteristics," Schachtel said. "We think we can make these tubes of superior quality because of our experience with sub-miniature tubes for hearing aids."

New Name for Karet Co.

R. M. Karet Associates, Inc., manufacturers representatives in the Chicago area, has changed its corporate name and will now be known as JKM Incorporated: J, for Oden Jester, K, for Bob Karet, and M, for John Margolin. The company also has added Will Brooks, formerly field engineer for the Ross Manufacturing Co., to its staff.

Enjoy the ADDED Beauty
of Your Lighted Tree
in MOTION . . .

KASSON ELECTRIC CHRISTMAS TREE TURNER

Revolves
3 times
a Minute

Adjustable
to most
Tree Sizes!



Ideal for holiday windows and for Christmas displays throughout the store. Sturdy, dependable A.C. motor. Will last for years.

Modern Merchandise Displays
Need LIGHTED MOTION!

New Model 712 revolves 3 RPM while permitting novel, self-contained lighting effects, or operation of electrical devices. 200 lbs. capacity. 18" dia. turntable. Will revolutionize your window trim!

KASSON
Roto-Sho
ELECTRIC TURNABLES



• Write for complete turntable catalog!
GENERAL DIE AND STAMPING CO.
Integrity Since 1919
Dept. TV, 262 Mott St., New York 12, N. Y.

"HAVE YOU HEARD
THE SOUND OF QUALITY?"



NEWCOMB SOUND IS BETTER

- Manufacturers of public address, mobile, phonograph, musical instrument and wired music amplifiers • Portable systems • Portable phonographs and radios • Transcription players • Rack and panel equipment.
- Write today! Circle items of interest and indicate whether you are a Dealer, Parts Jobber or Sound Specialist.

• **NEWCOMB AUDIO PRODUCTS CO.**
• DEPT. A, 6824 LEXINGTON AVE.
• HOLLYWOOD 38, CALIFORNIA

TWIN LEAD, TELEVISION LIGHTNING ARRESTER



APPROVED for OUTDOOR-INDOOR Use \$2.25
Protects Television Sets
Against Lightning and Static
Charges

JFD SAFE TV GUARD

Simple to install everywhere and anywhere
...no stripping, cutting or spreading of
wires. More than 300,000 in use today!

SEE YOUR JOBBER OR WRITE TO

JFD MANUFACTURING CO., Inc.
6127 16th Avenue, Brooklyn 4, N. Y.
First in Television Antennas & Accessories

The World's Finest LIGHTNING ARRESTERS



MODEL RW-204

The first and only lightning arrester that will accommodate 4-wire line for antenna rotator installation as well as regular 2-wire transmission line.

Only \$1.50 List

MODEL RW-300

For use with 2-wire standard antenna ribbon type transmission line for TV or FM. An air gap plus resistors provide double protection.



Only \$2.00 List

VEE-D-X

LaPointe-Plascomold Corp., Unionville, Conn.

INDEX TO ADVERTISERS

November 1950

Admiral Corp.	11
Air King Products Co., Inc.	Cover 2
Alliance Mfg. Co.	101
Allied Electric Products, Inc.	58
American Phenolic Corp.	14
American Telephone & Telegraph Co.	103
American Television, Inc.	84d
American Television & Radio Co.	116
Anchor Radio Corp.	51
Arvin Industries, Inc.	32, 55
Barb City Industries, Inc.	114
Capehart-Farnsworth Corp.	34
Circle-X Antenna Corp.	110
Clarostat Mfg. Co., Inc.	20
Clippard Instrument Lab., Inc.	116
Columbia Records	26
Commercial Credit Corp.	85
Commercial Trades Institute	108
Decca Records	35
DeWald Radio Mfg. Corp.	110
DuMont Labs., Inc., Allen B.	25, 93
Duotone Co., Inc.	14
Easy Up Tower Co.	90
Eicor Inc.	98
Emerson Radio & Phonograph Corp.	30
Eureka Television & Tube Corp.	104
Fada Radio & Electric Co., Inc.	6, 7
General Die & Stamping Co.	114
General Electric Co.	4, 8, 9, 12, 13, 95
Haugen Co.	84c
Hotpoint, Inc.	31
Hytron Radio & Electronics Corp.	97
Jewel Radio Corp.	17
JFD Mfg. Co., Inc.	115
Landers, Frary & Clark	22, 23
LaPointe-Plascomold Corp.	115
Master Garment Corp., Geo.	113
Meissner Mfg. Div., Maguire Industries	112
Motorola, Inc.	Cover 3
Newcomb Audio Products Co.	114
Oxford Electric Corp.	102
Penn Boiler & Burner Mfg. Corp.	106
Pentron Corp.	109
Permo, Inc.	94
Philco Corp.	5
Philson Mfg. Co., Inc.	116
Phoenix Electronics, Inc.	84c
Radiart Corp.	74
Radio Corp. of America	40, 41, Cover 4
Radion Corp.	99
Rauland Corp.	89
Rauland-Borg Corp.	104
Raytheon Mfg. Co.	87
Raytheon Television	57
Reeves Soundcraft Corp.	112
Revere Camera Co.	91
Rider Publishers, Inc., John F.	84, 84a
Schott Co., Walter L.	107
Sentinel Radio Corp.	59
Shure Brothers, Inc.	88
Simpson Electric Co.	28
Sparks-Withington Co.	61
Standard Coil Products Co., Inc.	82, 83
Standard Register Co.	15
Standard Transformer Corp.	108
Stewart-Warner Corp.	21
Stromberg-Carlson Co.	36
Sylvania Electric Products, Inc.	27, 81
Symphonic Radio & Elec. Corp.	84c
Technical Appliance Corp.	16
Tele-King Corp.	2, 3
Television Digest	92
Television Equipment Corp.	86
Tel-O-Tube Corp. of America	10
Telrex, Inc.	24
Thomas Electronics, Inc.	Insert 65-72
Tung-Sol Lamp Works, Inc.	100
V-M Corp.	96
Webster-Chicago	18, 19
Westinghouse Electric Corp.	29
Wheeler Insulated Wire Co.	115
Wilcox-Gay Corp.	33
Zenith Radio Corp.	63

T. V. INSTALLERS SERVICE CREWS

SAVE

TIME

AND CUT CALL-BACKS

BY USING

WHEELER

VOICE-POWERED

HANDSETS

NO BATTERIES OR POWER SUPPLY

RUGGED - SIMPLE DEPENDABLE EASY TO USE



ALWAYS READY...ORDINARY TWO-WIRE CONNECTION...LOW COST

Constant, clear two-way conversation between T. V. aerial and set locations with Wheeler self-powered Handsets speeds alignment and adjustment...enables operators to do the job right the first time.

Furthermore, Wheeler Handsets are built to take it on the job the same as your other service equipment...they are light in weight, ruggedly built, last for years and will quickly repay their low first cost in time savings alone. Always ready for use indoors or out, at any distance up to 25 miles. Write for literature or order direct from your electrical or electronics jobber.

SELL THEM TOO!

Wheeler Handsets are almost a necessity for power line service crews, fire, police, utility and civil defense emergency use...farmers, contractors, even householders. Also available as complete intercom systems. Write us.

THE WHEELER

INSULATED WIRE CO. INCORPORATED
DIV. of The SPERRY CORP.

1120 EAST AURORA ST.
WATERBURY 20, CONN.



3WH50

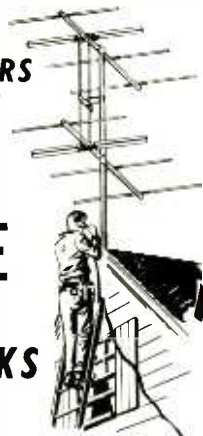



VIBRATORS!
By every test

ATR

is Best!

ATR
AUTO RADIO
VIBRATORS
have Ceramic Stack Spacers



A COMPLETE LINE OF VIBRATORS . . .
Designed for Use in Standard Vibrator-Operated Auto Radio Receivers. Built with Precision Construction, featuring Ceramic Stack Spacers for Longer Lasting Life. Backed by more than 19 years of experience in vibrator Design, Development, and Manufacturing.

ATR PIONEERED IN THE
VIBRATOR FIELD.

NEW MODELS **NEW DESIGNS**
NEW LITERATURE

"A" Battery Eliminator, DC-AC Inverters
Auto Radio Vibrators
See your jobber or write factory

ATR

AMERICAN TELEVISION & RADIO CO.
Quality Products Since 1931
SAINT PAUL 1, MINNESOTA—U. S. A.

RCA Victor Appointments

Election of Charles M. Odorizzi as operating vice-president of the RCA Victor Division, Radio Corp. of America, has been announced by Walter A. Buck, vice-president and general manager of the division. In his new post he will continue as chairman of the board of the RCA Service Company.

Also announced was the election of Edward M. Tuft, as vice-president and director of the personnel department for the RCA Victor Division.

New Vee-D-X Home

Jerome E. Respass, president of The LaPointe-Plascomold Corp., manufacturers of Vee-D-X TV antennas and accessories, announced that the company has purchased an entire new plant located at Windsor Locks, Conn. Because of its greater size, he said, LaPointe will now be able to more than double its present production.

DuMont Appointees

Joseph H. Moss, Jr. has been appointed to the newly established post of manager of distribution for the receiver sales division, Allen B. DuMont Laboratories, Inc., Walter L. Stickel, national sales manager, has announced. Also announced was the appointment of Albert C. Allen as assistant Central States regional sales manager for the receiver sales division.

Tele-Tone Distributor

Bregenzner Distributing Co., 1607 Hennepin Ave., Minneapolis, has been appointed to handle the complete Tele-tone radio and television line in its territory, it was announced recently by Morton M. Schwartz, Tele-tone general sales manager.

Webster Chicago TAPE RECORDER

Retailing at about \$179, the new recorder operates at 3 3/4 or 7 1/2 inches per second. With double track, up to two hours of recording can be done without interruption. At fast reverse speed,



a 1,200 ft. reel runs through in 3 minutes. Has a new leader with automatic stop at end of reel. Portable carrying case. Unit includes microphone, tape, empty reel; weighs 40 pounds. Webster-Chicago Corp., 5610 W. Bloomingdale, Chicago 39, Ill.—RADIO & TELEVISION RETAILING.

When your customers
want the best

-- specify
ANTENNAS by
PHILSON

Dealers throughout the country have been quick to realize that Philson automobile and TV antennas prove themselves Best By Test.

Write for Free illustrated catalog now!

PHILSON

The LEADER for
Value, Performance
and Quality.

MANUFACTURING CO., INC.

60-66 SACKETT STREET BROOKLYN 31, N. Y.

SHOOTS TROUBLE FASTER!
MAKES MORE MONEY FOR YOU
ON JOB OR AT SERVICE BENCH!



PRICE
\$9.95

at distributor
or postpaid,
direct. No
COD's please
Ohioans add
3% State
Sales Tax.

Signalette

MULTI-FREQUENCY GENERATOR

In radio service work, time means money. Locate trouble faster, handle a much greater volume of work with the SIGNALETTE. As a trouble shooting tool, SIGNALETTE has no equal. Merely plug in any 110V. AC-DC line, start at speaker end of circuit and trace back, stage by stage, listening in set's speaker. Generates RF, IF and AUDIO Frequencies, 2500 cycles to 20 Megacycles. Also used for checks on Sensitivity, Gain, Peaking, Shielding, Tube testing. Wt. 13 oz. Fits pocket or tool kit. Satisfaction, or money back! See at your dist. or order direct.

Clippard Instrument
Laboratory,
Inc.

Dept. G, 1125 Bank St., Cincinnati 14
Qualified Jobbers write, wire for details.

MOTOROLA TELEVISION

The
BIG DEMAND
This Christmas will be for



Motorola TV

Beautiful Cabinets . . . Brighter Pictures and Powerful Advertising Campaigns in 19 Magazines, Over Radio and TV, and National Newspaper Ads, Are Building Greater Demand for Motorola!

● The new Motorola TV is breaking all records for sales demand . . . Style-wise, it has the FASHION ACADEMY AWARD! Sales-wise, it has every advanced feature your customers want. And promotion-wise, it blankets the nation

with a multi-million dollar campaign that hits harder and faster than anything you've ever seen. Your biggest Christmas season is here! Feature MOTOROLA TV and top the field in profits.

GET THESE DISPLAYS FOR YOUR STORE



● This life-size window display in full color attracts Christmas gift shoppers to your windows. Get it from your distributor!



● Here's your promotion package for best attention value! Streamers, Christmas trees, unusual choraleer cutouts . . . everything you need for window and floor display.

Contact Your Motorola Distributor Today

Motorola Inc.

4545 AUGUSTA BLVD., CHICAGO 51, ILLINOIS

Awarded FASHION ACADEMY GOLD MEDAL for Distinctive Styling



Now... the new RC-16

RCA RECEIVING TUBE MANUAL

- ✓ Up-to-the-minute
- ✓ Over 300 pages
- ✓ Latest TV tube data
- ✓ Over 460 tube types
- ✓ "Lie-flat" binding
- ✓ Expanded circuit section



... you should have these other "RCA firsts" in authoritative technical literature

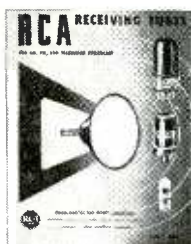

Receiving Tubes for AM, FM, and Television Broadcast.
Bulletin 1275-E. Characteristics and base diagrams on over 450 RCA receiving tubes. 24 pages. Price 10 cents.



New RCA Triple Pin Index at your fingertips ... any 3 base diagrams out of over 600 receiving tubes and kinescopes. Price 75 cents.

RCA Television Pict-O-Guides. For quick and accurate TV trouble shooting by picture analysis. (See your RCA Tube Distributor for details.)



Months of planning and preparation went into the new RC-16 Receiving Tube Manual to produce what is unquestionably the most complete and authoritative reference guide to receiving-type tubes ever published.

Patterned after the famous RC-15—of which over 600,000 copies were sold—and retaining its proved features, the new and larger RC-16 contains over 300 pages of detailed information on more than 460 RCA receiving tubes and kinescopes.

Features include

... tube and circuit theory with formulas and examples for calculating power output, load resistance, and distortion for several classes of amplifiers—plus new information on cathode follower design.

... new information on kinescope installation and handling.

... a classification chart which groups types having similar characteristics and the same filament or heater voltages. Also shows miniature types and their GT equivalents.

... expanded circuit section, including many new audio amplifier and receiver designs.

... design data and charts for resistance-coupled amplifiers.



A textbook in itself, the new RC-16 is the most valuable day-to-day tube reference guide in the field ... yet it costs only 50 cents! **Get your copy today from your local RCA Tube Distributor.**

For quick action—

-----Mail this coupon to your **RCA TUBE DISTRIBUTOR** *-----

Mr. RCA Tube Distributor:

Please rush RCA Technical Literature checked below for which remittance is enclosed—

Name _____

Address _____

City _____ Zone _____ State _____

- RC-16 RCA Receiving Tube Manual (50 cents) Receiving Tubes for AM, FM, and TV (10 cents)
- RCA Triple Pin Index, New Edition (75 cents) Tell me how I can obtain Volume I Volume II of the RCA Pict-O-Guide



**RADIO CORPORATION
of AMERICA**

ELECTRON TUBES HARRISON, N. J.

*If you do not know your RCA Tube Distributor, orders may be sent to RCA, Commercial Engineering, Section K53U, Harrison, N. J.